

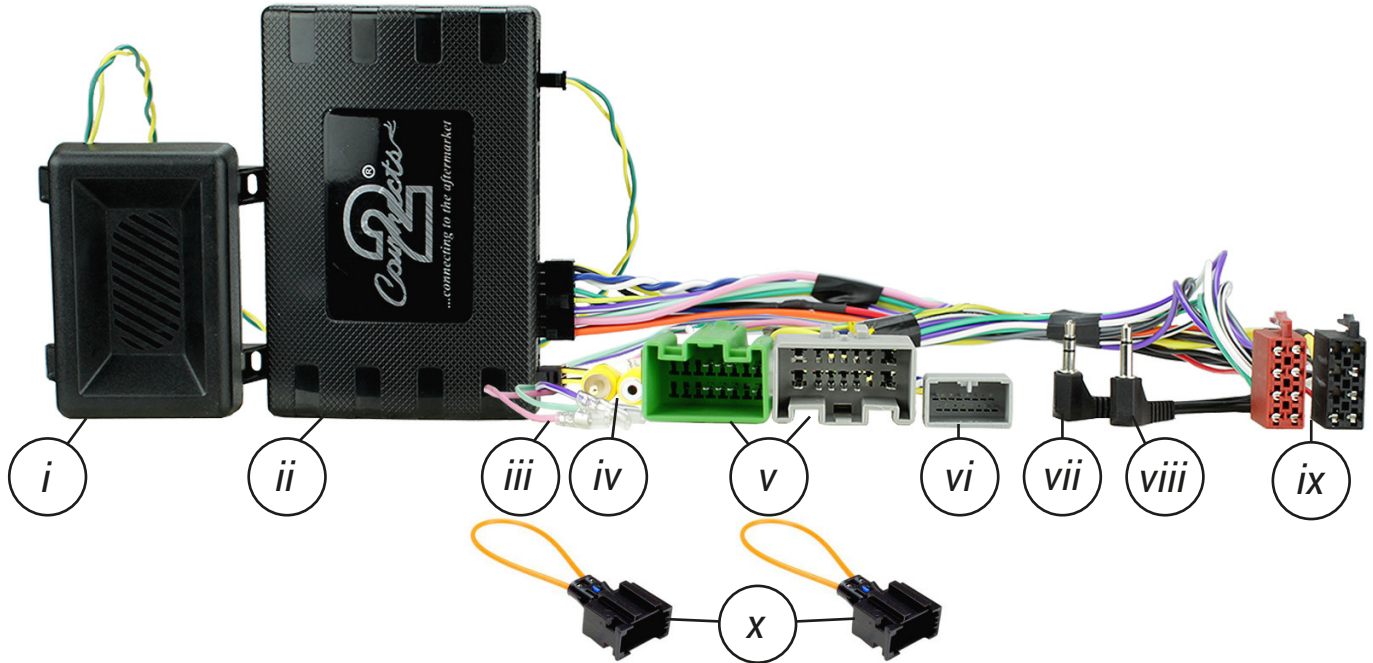

CTUVL03

# Infodapter Interface for Volvo Vehicles



- i. Speaker Module
- ii. Interface Box
- iii. Flying Wires
- iv. Yellow Camera RCA Connectors
- v. Volvo Amp & Power Connection
- vi. CAN Data Connector
- vii. OEM 3.5mm Aux Retention
- viii. OEM 3.5mm Mic Retention
- ix. ISO Connector
- x. MOST Loops (x2)

Designed and  
Engineered  
in the UK. 

## APPLICATION

Note: Application data is subject to change at any time

Volvo V70	2012 - 2016
Volvo XC70	2012 - 2016

For amplified vehicles.

## FEATURES

- Retains Steering Wheel Control Functionality
- Retains Phone Button Functionality
- Retains Microphone and AUX Inputs (if applicable)
- Retains Reversing Camera
- Retains Amplified System
- Retains Climate Control Settings including Heated Seats
- Generates Rear Parking Sensor Audio & OEM Parking Sensor Graphics
- Provides Outputs for Park Brake, Reverse Gear & Speed Pulse
- Updateable via USB (contact supplier for more information)

### DISCLAIMER

The information provided in this document is subject to change without notice due to manufacturer changes and/or improvements to the product/s. This instruction manual is based on documented data and research. The manufacturer of this product cannot be held responsible for any changes made to the vehicle by the manufacturer or damages that may occur through the installation of this product in accordance with the steps outlined herein.

# PRODUCT INFORMATION

## CTUVL03

The Infodapter interface aids the installation of an aftermarket stereo into an OEM dashboard. It helps retain steering wheel control presets as well as retaining vital features and functions which include the reverse camera and rear parking sensors (if applicable).

**Note:** This product is for amplified vehicles only.

## WIRING KEY

### IN ISO CONNECTOR

Purple	Right Rear Speaker +	Yellow	Permanent 12V
Purple/Black	Right Rear Speaker -	Black	Ground
Green	Left Rear Speaker +	Red	Ignition 12V
Green/Black	Left Rear Speaker -	Orange	Illumination
Grey	Right Front Speaker +		
Grey/Black	Right Front Speaker -		
White	Left Front Speaker +		
White/Black	Left Front Speaker -		

### ADDITIONAL CONNECTIONS

Pink	Speed Pulse	Yellow RCA	Reverse Camera
Green	Park Brake	3.5mm (AUX)	Aux Retention
Purple/White	Reverse Gear	3.5mm (MIC)	Microphone Retention

## INTERFACE CONNECTIONS

- ① Reverse Camera Extension Harness Input
- ② Power Harness Input
- ③ Stereo Connection (Patch) Lead Input
- ④ DIP Switch 1 - 'ON' for Pioneer, 'OFF' for other brand stereo  
DIP Switch 2 - 'ON' for PAL reversing camera, 'OFF' for NTSC reversing camera (Default is 'OFF'/NTSC)  
DIP Switch 3 - Change from 'OFF' to 'ON' and back to reset screen settings to factory defaults.  
**Note:** During this procedure, the screen background will change to red and no settings adjustments can be made.  
DIP Switch 4 - Not Used
- ⑤ Not used

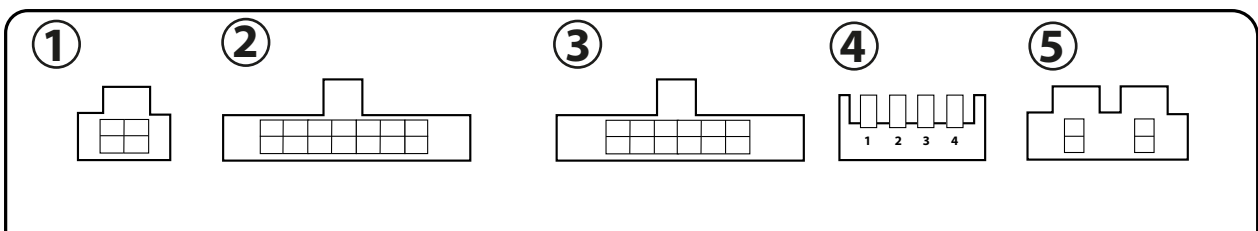

# PRIOR TO INSTALLATION

Read the manual prior to installation. Technical knowledge is necessary for installation. The place of installation must be free of moisture and away from heat sources. Please ensure that the correct tools are used during the installation to avoid damage to the vehicle or product.

**Connects2 can not be held responsible for the installation of this product.**

## INSTALLATION GUIDE

See Wiring Diagram on Pg.6 for more information

Before installing the interface, the factory stereo must be removed and disconnected. To do this, please consult the vehicle owner's manual/handbook or contact a fitting professional.

A stereo connection (patch) lead is also required for the installation of this interface (supplied separately). Please ensure that you have the correct lead before proceeding. For universal patch leads, prepare the wiring loops in accordance with the instruction manual supplied with the product before installation.

1. Connect the 12 Pin connector from the stereo connection (patch) lead to the interface box.
2. Connect the opposite end of the stereo connection (patch) lead to the steering wheel control input on the back of the aftermarket stereo.

*NOTE: This may be a 3.5mm jack connector or a wired input depending on the brand of aftermarket stereo being fitted. Please consult the aftermarket stereo installation manual for further information on where to make the connection*

**! IMPORTANT: THIS STEP MUST BE COMPLETED BEFORE CONNECTING POWER TO THE INTERFACE.  
FAILURE TO DO SO MAY RESULT IN A LACK OF FUNCTIONALITY AND THE NEED TO REINSTALL THE PRODUCT.**

3. Connect the 14 Pin connector from the supplied wiring loom and the 2 pin speaker wire to the interface box.
4. Connect 4 Pin camera extension harness to the interface box.
5. Connect the power/speaker ISO connector to the power/speaker ISO connector at the rear of aftermarket stereo.

*Note: For aftermarket stereos which do not have an ISO connector, please see 'Wiring Key' on Pg.2 for information on which wires to connect. Some interfaces may also have additional 'flying' wires which can be connected to the vehicle to support various features i.e. parking brake trigger, reverse gear and speed pulse. Details of these can be found under 'Additional Connections'.*

6. Connect additional flying wires from the main wiring harness to the stereo as required

**Note: the Reverse Gear wire must be connected for the interface to function correctly.**

7. Connect the 2x MOST loop connectors that come with the kit to vehicle's OEM fibre connections located behind the stereo and the OEM amplifier.
8. Connect the 3.5mm jack connectors to the back of the aftermarket stereo to retain the vehicle's OEM Aux input and Microphone.
9. Connect the Amplifier connector to the vehicles OEM Amplifier (located underneath the driver seat/rear of vehicle).
10. Connect the CAN Data connector to the vehicles OEM connector.
11. Connect male yellow RCA from the camera extension harness to the reverse camera input of the aftermarket stereo.
12. Connect the OEM Specific/Quadlock power connector on the supplied harness to the relevant OEM connector from the vehicle.
13. Test stereo and steering wheel control functionality for correct operation before reassembling the vehicle dashboard. If steering wheel control functions are unresponsive, please uninstall the interface and wiring and reinstall carefully in accordance with the above steps.

**For further help, please contact and fill out a support ticket with the full details of your issue at:  
[support.connects2.com/tickets/technical](https://support.connects2.com/tickets/technical)**

# USER GUIDE

## STEERING WHEEL CONTROL FUNCTIONALITY

The following diagram, though based on careful research, is an example only. Individual steering wheel control configurations may differ.

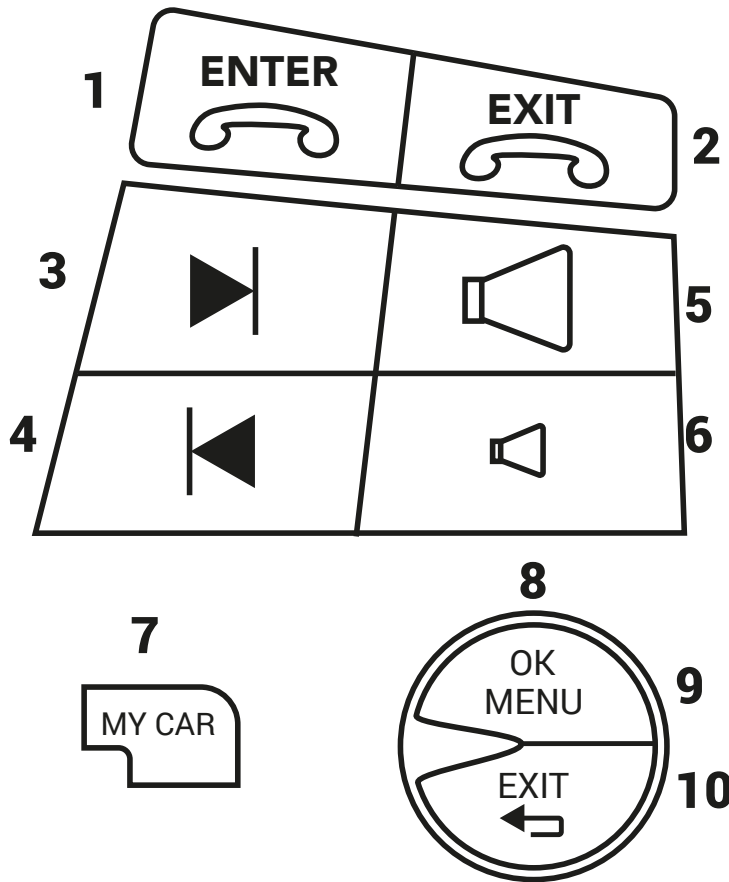

### In Normal Mode

1. Pick Up (where vehicle doesn't allow use *fig.9*)
2. Hang Up (where vehicle doesn't allow use *fig.10*)
3. Track Forward
4. Track Back
5. Volume Up
6. Volume Down
7. **Enter Infodapter Menu**

### In Infodapter Mode

8. Navigate options up/down (*use rotation*)
9. Select Menu Item
10. **Back/Exit Infodapter Menu**

## INFODAPTER MENU

**IMPORTANT:** When installation is complete and you first power on the vehicle, you **MUST** go through and select the appropriate options to ensure the OEM setting memory is able to communicate properly.

Pressing the **MY CAR** Button (*fig 7*) located on the OEM button panel will access the 'Configuration Menu'. The Infodapters 'Configuration menu' showcases a series of options and settings that can be altered to tailor the users experience:

### MY CAR

The 'My Car' menu option contains all of the vehicles original settings. All vehicle setup options that were available with the original radio are now available through the aftermarket stereo.

**See the vehicle handbook for more information regarding these features.**

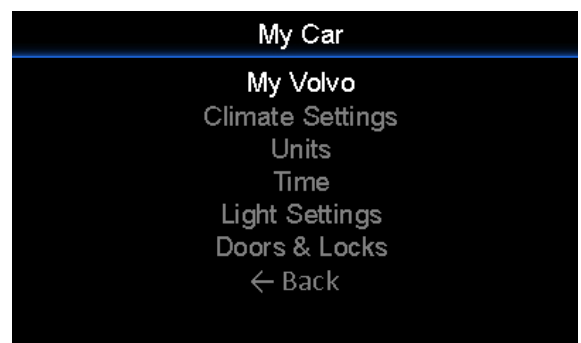
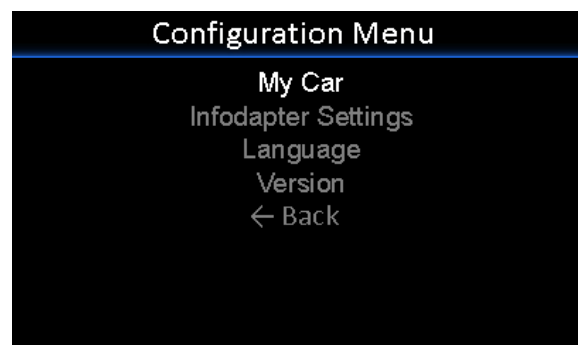

# INFODAPTER MENU

## INFODAPTER SETTINGS

The 'Infodapter Settings' menu contains parameters that can be selected to enhance/adapt the Infodapters layout and functionality.

### SCREEN SIZE/POSITION

Allows the user to setup the Infodapter display screen to the exact size of the aftermarket stereo being fitted.

### PICTURE SETTINGS

Allows the user to adjust the Brightness, Contrast and Saturation levels of the Infodapter menus/parking graphics.

### PREFERENCES

#### • **Camera Connected**

Select 'Yes' if an optional camera is connected

#### • **Reverse Priority**

Select which image (Camera or Park Assist) will be shown by default when reversing.

*(Note: this option is only available when Camera Connected is set to 'Yes')*

#### • **Park Assist Version**

Select according to the colour configuration of the park assist fitted to the vehicle.

#### • **Driver Position**

Select according either LHD (Left Hand Drive) or RHD (Right Hand Drive) for drivers position.

#### • **Park Brake Source**

Set Park Brake output to activate when park brake is on (**Brake**), when speed is less than 3km/h (**Speed**) or to remain on at all times (**Always On**)

#### • **Restore Factory Settings**

Select Yes to return all Infodapter settings to factory defaults

## LANGUAGE & VERSION

The latter of the settings menu gives the user a selection of languages - English/French/German/etc. - as well as the ability of viewing the current version history.

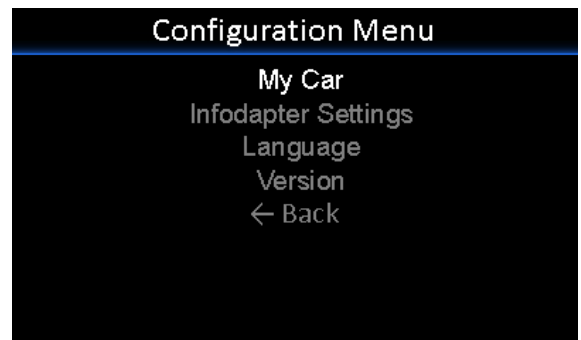
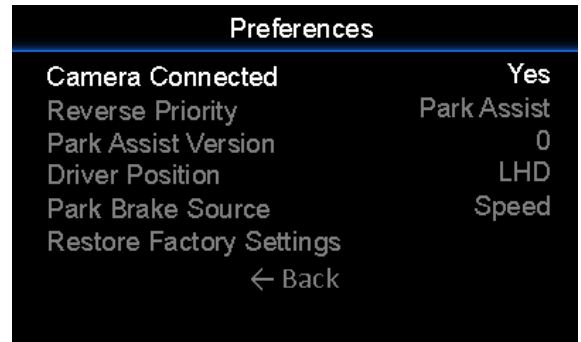
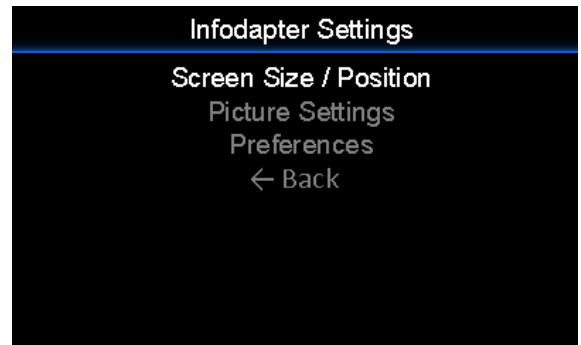

# WIRING DIAGRAM

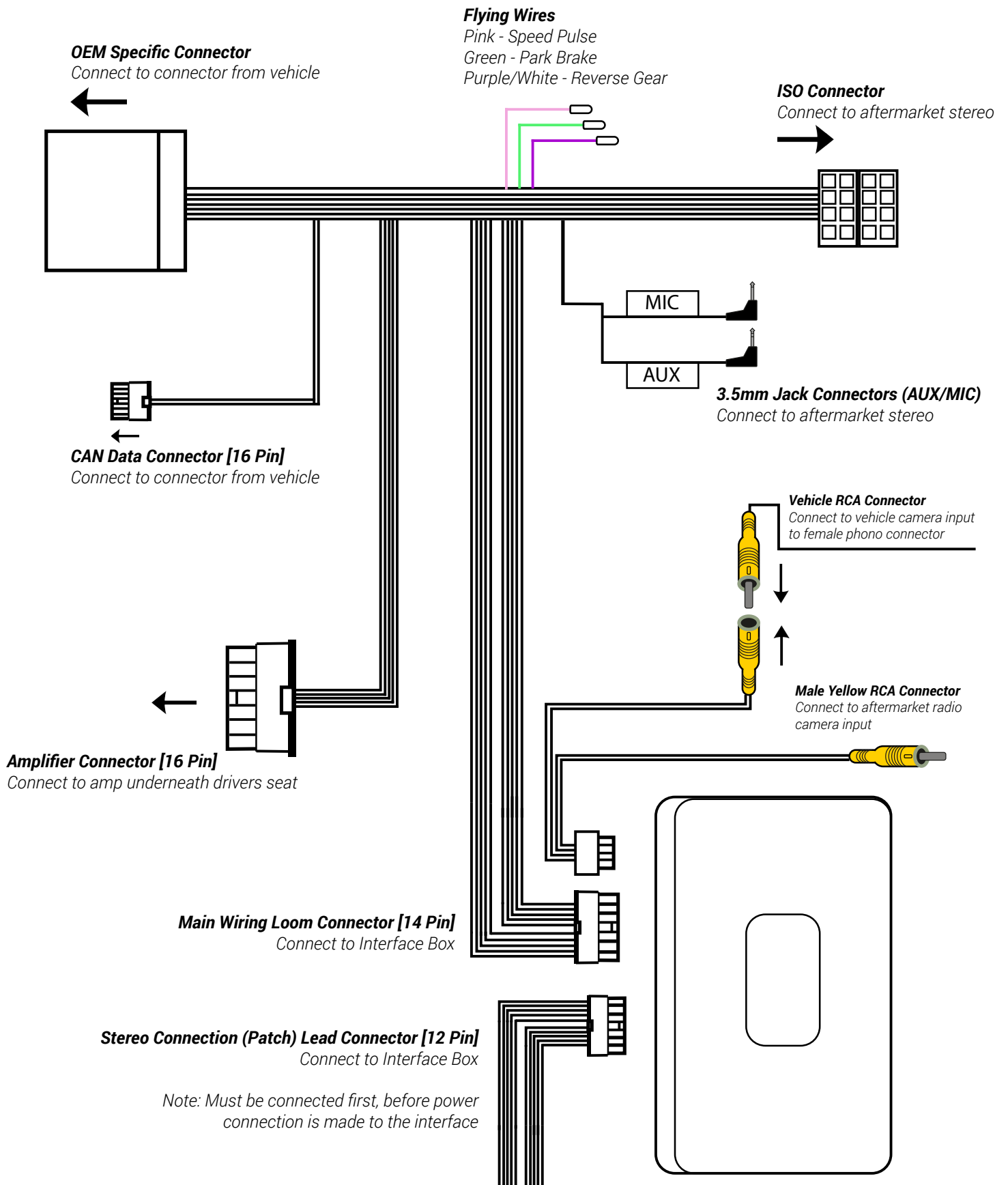

Need help? Visit [support.connects2.com/tickets/technical](https://support.connects2.com/tickets/technical)

# NOTES

---

# NOTES









---



## Configuration Assignments (1=Link made, 0=No Link)

J1	J2	J3	Systems	Connector
1	0	0	JVC	Jack/Key1
0	1	0	BEAT/Philips/Nakamichi	Key1
1	1	0	Clarion	Jack
0	0	1	Kenwood	Key1
1	0	1	Alpine	Jack
0	1	1	Panasonic	Key1
1	1	1	Sony/LG/Pioneer	Jack
1 (Pin12)	1 (Pin10)	0	Zenec	Key1
1	1	1	Chinese Learning Brands	Key1, Key2, GND

## Pin Configuration

Pin 1	Description
1	Reserved
2	Reserved
3	Reserved
4	Analog 2 Swc 
5	GND Swc 
6	Analog 1 Swc 
7	Link J3 
8	Link J3 
9	Link J2 
10	Link J2 
11	Link J1 
12	Link J1 

Here are some Examples of how to make various patch Leads:

**Example 1: Alpine - Remove Link J2 then use the Jack connector into radio.**

**Example 2: Kenwood - Remove Link J1 and J2, use the wire connector to Radio.**

**Example 3: Zenec - Remove Link J3, Cut Orange and Green then solder top row (Pin 12 & 10) together and insulate. Use the Wire connector to Radio.**

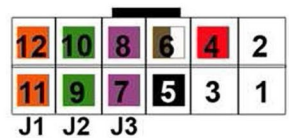

## Universal Patch Lead

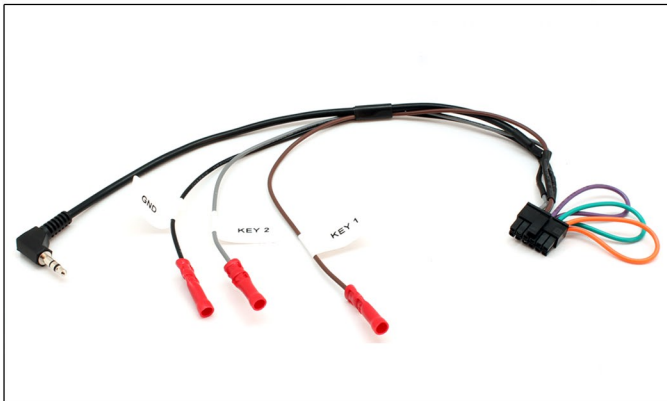

## Examples:

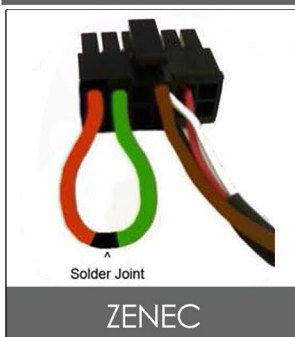



**CT23VL08L**

## **Double DIN Fitting Kit** *for Volvo Vehicles*



### **IN THE KIT**

- Double DIN Fascia Panel
- Radio Brackets

### **APPLICATION**

*Note: Application data is subject to change at any time*

<b>Volvo V70</b>	<b>2012 - 2016</b>
<b>Volvo XC70</b>	<b>2012 - 2016</b>

*Note: this fascia is suitable for left hand drive vehicles only. The dashboard will need to be modified for installation of a new unit.*

### **FEATURES**

- Allows for the installation of a double DIN aftermarket stereo
- Includes mounting brackets
- Finished in black to match vehicle dashboard

#### **DISCLAIMER**

*The information provided in this document is subject to change without notice due to manufacturer changes and/or improvements to the product/s. This instruction manual is based on documented data and research. The manufacturer of this product cannot be held responsible for any changes made to the vehicle by the manufacturer or damages that may occur through the installation of this product in accordance with the steps outlined herein.*

# PRIOR TO INSTALLATION

Read the manual prior to installation. Technical knowledge is necessary for installation. The place of installation must be free of moisture and away from heat sources. Please ensure that the correct tools are used during the installation to avoid damage to the vehicle or product. **Connects2 can not be held responsible for the installation of this product.**

## INSTALLATION GUIDE

### DASH DISASSEMBLY

1.

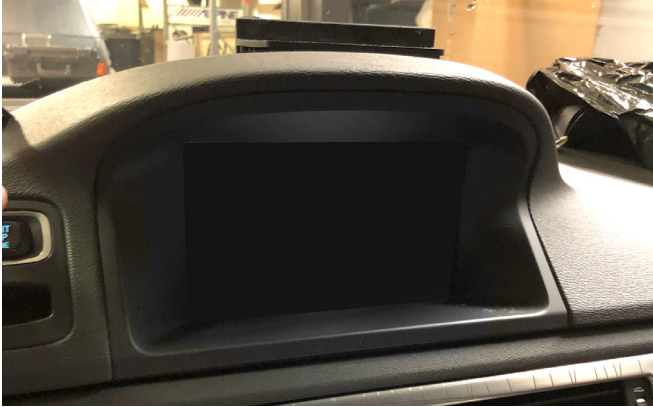

Begin by using a panel removal tool to remove the fascia trim panel.

2.



Disengage the CD slot plastic housing by bending in the clips on the inside of the slot with a panel removal tool.

3.



With the CD slot panel removed, proceed to undo the 2x Torx screws highlighted.

4.

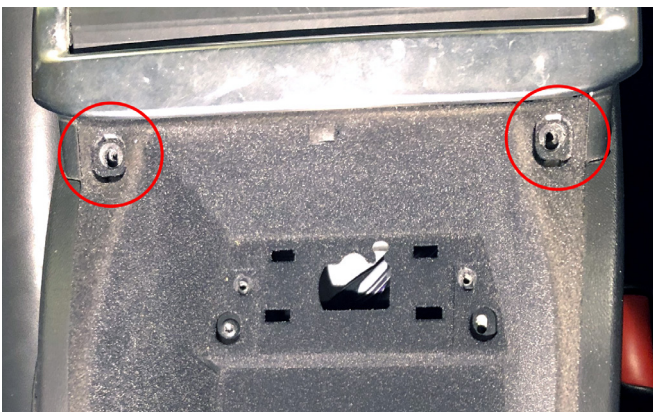

Open the centre console armrest and use the panel removal tool to help remove the rubber grommets that cover the following screws. Once uncovered, remove the 2x Torx screws.

# INSTALLATION GUIDE

## DASH DISASSEMBLY

5.



Located around the back of the main panel frame are 2x screws. These 2x Torx screws will also need to be removed.

6.



With the all of the screws undone, proceed to pull the main panel off of the dashboard, disconnecting the following connector in the process.

7.



Once the main panel is removed, undo the 2x bolts on either side of the main head unit. When done, remove completely whilst disconnecting all of the wiring.

8.

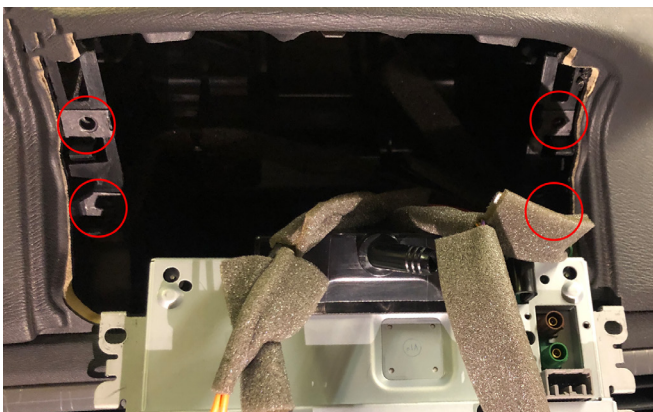

Remove the 4x screws that surround the top screen and remove completely whilst disconnecting all of the wiring.

*Note: this top screen can go into storage as it will not be needed going forward.*

# INSTALLATION GUIDE

## DASHBOARD MODIFICATION

9.



The highlighted section of dashboard frame will need to be filed down (roughly 2mm) in order for a new double DIN unit to sit in place correctly.

*Note: this should be done purely for the fitment of the stereo. If the unit can already fit flush, then disregard this step.*

***When performing any modification to the vehicle, always ensure to measure where the stereo will sit and take due care when performing modifications to the vehicle.***

***Connects2 always promotes the use and expertise of professional installers. Connects2 will not be held responsible for any damage to the vehicle.***

## DASH ASSEMBLY

10.



Affix the brackets to the correct sides of the stereo. Then test fit into the dashboard. If the fit is too tight, repeat *Step 9* and repeat fit. When happy with the fitment, feed the wires up from the main cavity and connect the wiring to the stereo, screwing into place using the pre-existing screws.

11.



Once the stereo is secured, take the new fascia and place over the top. Reassemble the rest of the dashboard in reverse order to complete the installation.