

**GAS**  
AUDIO POWER

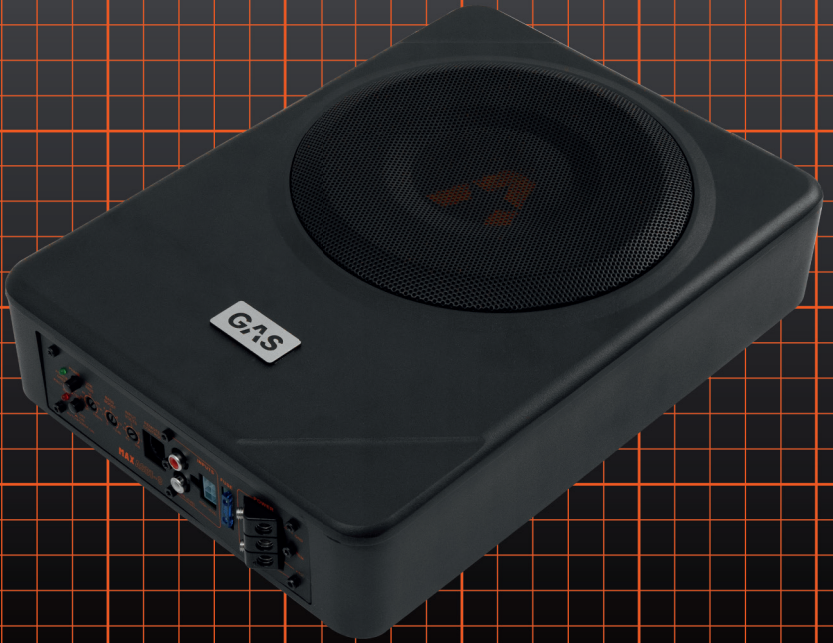

# MAX ASB1

ASB1-8 / ASB1-10

**HARDCORE CAR AUDIO**

MAX USER MANUAL

## **WE PLAY LOUD!!**

We know what you want. You want it LOUD, and that is exactly what we do, what we live for. Vibrations, gut-punches and straight up loud music - that's what makes us tick. We won't dress up in fancy words or claim to be something we're not. We are the NO BULLSH!T car audio brand!











Every single product with the GAS logo on it is born out of passion, the same that has driven us for two generations and that will keep us rolling up to your neighbourhood, winning and pushing the limits for many generations to come!

It's up to you to choose your own level of loud, and if you don't like what we do that's OK. You are welcome back when you've had your first true GAS experience. We don't exclude, we don't judge and we do not make up any excuses for who we are.

We are GAS and we are proud to be LOUD!

# **GAS**

# TABLE OF CONTENT

 SAFETY.....	3
 UNPACKING.....	4
 DIMENSIONS.....	4
 SPECIFICATIONS.....	5
MAX ASB1-8.....	5
MAX ASB1-10.....	5
Recommended cables.....	6
 FEATURES.....	7
Impressive compact bass.....	7
Optimized power.....	7
Simple installation.....	7
Full control.....	7
 FUNCTIONS.....	8
 HOW TO.....	10
Install active slim subwoofer.....	10
Tweaking & settings.....	13
 TROUBLESHOOTING.....	16
No power/sound.....	16
Unwanted noise.....	16
Distortion.....	16
 WARRANTY & DISPOSAL.....	17
 THE GAS WORLD.....	18



# SAFETY

**NO COMPROMISES!** Especially when it comes to safety. Before installing your MAX ABS1 series active subwoofer, make sure that you read through the manual and follow the instructions. Save the manual for future usage and reference!

Make sure to pay attention to the instructions when you see this symbol: 

Do not expose your new active subwoofer to excessive damp or moisture. If the active subwoofer is exposed it might result in electric failure, shock or damage to the product. Servicing is required when the product has been damaged in any way and/or doesn't operate normally. Refer all servicing to qualified service personnel only.

Keep the cables inside the vehicle separate from sharp edges or components that may be affected or take damage. Follow the recommended cable sizes and always use high quality cables and accessories. Even if you're eager to put the subwoofer to use - take no shortcuts when installing the cables, make sure that all connectors are protected and secured.

Do not drill any holes without checking what lies beneath, and don't cut anything without making sure that no important components risk being damaged.

There is a first time for everything, if you need help - ask a friend or contact your local GAS AUDIO POWER dealer/installer.

We want you to experience your products to the MAX, but we don't want you to injure yourself or others. Use common sense, respect high pressure levels and volume, and follow your local laws and regulations.





# UNPACKING

Unboxing your new MAX product is an experience, make sure that the active subwoofer and all the accessories are included in the packaging:

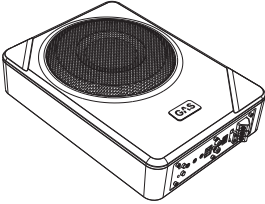

Subwoofer

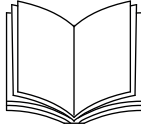

Manual

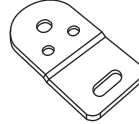

Brackets  
(4 pcs)

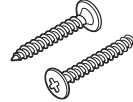

Screws  
(12 pcs)

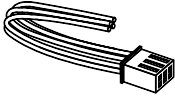

HI input cable



Remote cable



Remote

# DIMENSIONS

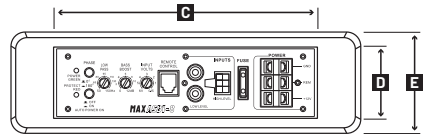
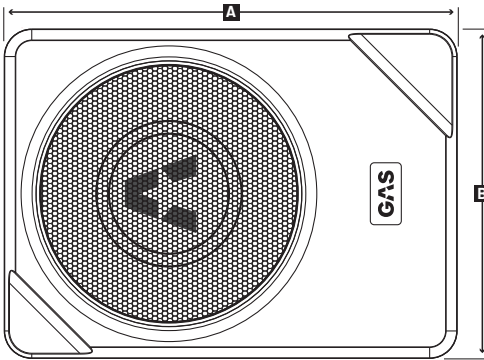

	A	B	C	D	E	
ASB1-8	342	242	170	44	85	mm
ASB1-10	360	263	174	44	87	mm

# SPECIFICATIONS

Below you'll find the specifications that has been checked and tested in our workshop. The specified sensitivity isn't directly connected with the sound pressure in the vehicle, and shouldn't be used as the sole indicator for comparison with other subwoofers.

<b>MAX ASB1-8</b>	
Component	Active Subwoofer
Size	8" (200mm)
Power* RMS	130W
Power* MAX	260W
Freq. response	20-150Hz
T.H.D	< 0.3%
Input sensitivity HI	1.0V-8.0V
Input sensitivity RCA	0.15V-6.0V
S/N ratio	> 95dB
Low pass filter	50-150Hz
Bass EQ	0-12 dB @ 45Hz
Subsonic filter	25Hz (fixed)
Phase	0/180
Damping factor	>120
Power fuse	15A
Power voltage	10-16V
REM voltage	11-15V
High level input	Yes, Auto ON/OFF
Low level input	Yes
Bass remote	Yes, level
Weight	4.04 Kg

\*Power @ 14.4V / 1% THD

<b>MAX ASB1-10</b>	
Component	Active Subwoofer
Size	10" (250mm)
Power* RMS	150W
Power* MAX	300W
Freq. response	20-150Hz
T.H.D	< 0.3%
Input sensitivity HI	1.0V-8.0V
Input sensitivity RCA	0.15V-6.0V
S/N ratio	> 98dB
Low pass filter	50-150Hz
Bass EQ	0-12 dB @ 45Hz
Subsonic filter	25Hz (fixed)
Phase	0/180
Damping factor	>125
Power fuse	20A
Power voltage	10-16V
REM voltage	11-15V
High level input	Yes, Auto ON/OFF
Low level input	Yes
Bass remote	Yes, level
Weight	4.65 Kg

\*Power @ 14.4V / 1% THD

# SPECIFICATIONS

## RECOMMENDED CABLE SIZES

<b>MAX ASB1-8</b>		
	<b>RECOMMENDED MIN SIZE</b>	<b>RECOMMENDED MAX SIZE</b>
Power cable	10AWG (6mm <sup>2</sup> )	8AWG (10mm <sup>2</sup> )
Speaker cable	14AWG (1,5mm <sup>2</sup> )	12AWG (4mm <sup>2</sup> )
REM cable	14AWG (1,5mm <sup>2</sup> )	12AWG (4mm <sup>2</sup> )
<b>MAX ASB1-10</b>		
	<b>RECOMMENDED MIN SIZE</b>	<b>RECOMMENDED MAX SIZE</b>
Power cable	10AWG (6mm <sup>2</sup> )	8AWG (10mm <sup>2</sup> )
Speaker cable	14AWG (1,5mm <sup>2</sup> )	12AWG (4mm <sup>2</sup> )
REM cable	14AWG (1,5mm <sup>2</sup> )	12AWG (4mm <sup>2</sup> )



# FEATURES

If you have this in your hand, you have finally made it. Congratulations! You are ready to take the next step, to enter a world of NO COMPROMISES with an active slim subwoofer that'll take the audio experience in your car to the next level. So get out there and impress the non-believers! Show them that true dedication is and that "good enough" just doesn't cut it.

## IMPRESSIVE COMPACT BASS

We want everyone to have access to truly great sound - even if it's in a smaller car or when you need the space in your trunk. Our engineers worked hard on how to manifest the MAX experience in a compact format that's so small it can fit under a seat. The MAX ASB1 was designed to test the limits and is packed with a lot of power, bass and impressive performance that fulfills your need for high quality bass.

## OPTIMIZED POWER

The subwoofer is equipped with the latest Class AB amplifier. Together with its enhanced performance, the amplifier can deliver up to 130/150W (RMS) directly to the 8/10" woofer. We know that LOUD is not good enough for you, not without the performance to match it. To make sure that the bass perfectly matches your sound system, we've included customizable settings such as a low-pass filter, bass EQ and 0°/180° phase shift control.

## SIMPLE INSTALLATION

When we say that everyone deserves great bass, we mean it. To achieve this, we made sure to make it easy for you to integrate the ASB1 with your current sound system. You won't even need a new head unit to connect it. There are two methods you can use: Low level (by using the RCA pre-out) or High level (by using the speaker cables). If you use the High-level input, the best-in-class pre-amplifier with Auto Sense Circuit allows the amplifier to turn on and off without the need for a remote turn on wire. It almost sounds too easy, right?

## FULL CONTROL

Going on a cruise or a longer road trip? If you want to listen to a different kind of music after a while, you still want to optimize the bass for that genre. The included bass remote gives you full access to adjusting the bass level whenever you want to. Simple and easy.



# FUNCTIONS

NO COMPROMISES - that's the spirit of the MAX series. The MAX active subwoofers are made for the enthusiasts out there who crave high precision audio! We've packed the active subwoofer with a bunch of interesting features. We know you're itching to get your new sound system going, but make sure to read through these pages - so you can get the most out of your setup!

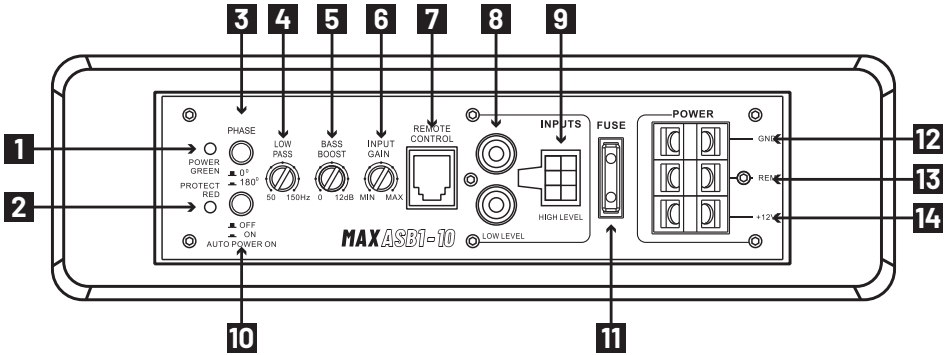

## 1 POWER LED LIGHT

The LED light glows green when the power is on.

## 2 PROTECTION LED LIGHT

The LED light glows red when the protection circuit is active.

## 3 PHASE SHIFT

Switch to compensate for time alignment in the sound system.

## 4 LOW PASS FILTER

Rotate to limit the output above selected frequency.

## 5 BASS BOOST (EQ)

Rotate to boost the bass at 45Hz, Variable between 0-12dB.

## 6 INPUT GAIN/VOLTS

Rotate to synchronize your head unit's output signal with the active subwoofer's amplifier.

 Read through and follow the HOW TO instructions.

## 7 REMOTE CONTROL INPUT

Use this to connect a remote level output control knob for an easy access and adjustment of the active subwoofer's output.



# FUNCTIONS

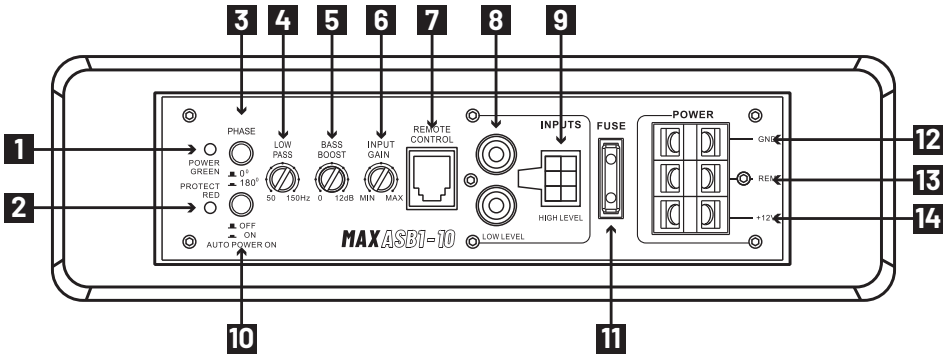

## 8 RCA INPUT (LOW LEVEL)

Connect to your head unit's RCA outputs (left & right channels).

## 9 HIGH LEVEL INPUT

Use instead of RCA/low level input to connect the subwoofer's output directly to the head unit.

## 10 AUTO TURN-ON

Turns on the active subwoofer automatically when it receives signal. **NOTE!** Can only be used with the High Level connection.

## 11 FUSE

Protects your subwoofer from major damage in case of a power failure. **NOTE!** Only use the proper load stated in the Specifications.

## 12 GROUND INPUT

Terminal input connector for the ground cable (- power cable).

## 13 REMOTE INPUT

Terminal input connector for the active subwoofer that controls the turn-on signal.

## 12 +12V INPUT

Terminal input connection for the +12V cable (+ power cable).

# HOW TO

A well-built sound system will set you aside from the rest and elevate your vehicle! It's important that you carefully read the instructions on the following pages. This is to make sure that you install and use the active subwoofer correctly, for the true MAX EXPERIENCE!

## INSTALL ACTIVE SLIM SUBWOOFER



Make sure your vehicle is up to task. You need a 12VDC negative ground electric system and the power source and the alternator should be fully functional and healthy.

**Disconnect and secure the negative terminal from your power source** to eliminate the risk of damaging yourself or the products. Place the negative terminal in a secure position so that it won't accidentally contact the positive or the negative power source post.

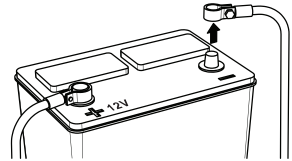

**Have all the necessary tools ready and close at hand.** Make sure that the needed wiring accessories are prepared. Your wiring kit should be of the recommended size stated in this manual (see the SPECIFICATION chapter).

**Find the perfect location to place your active slim subwoofer!** The ASB1 slim subwoofer has been made to fit under the seat of most modern car models. For a simple installation that takes up minimum amount of space. Always use great care when attaching a new product to your vehicle - Check clearances in front, behind and on both sides of the planned installation spot before drilling any holes or installing any screws.

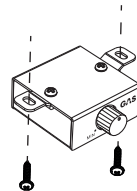
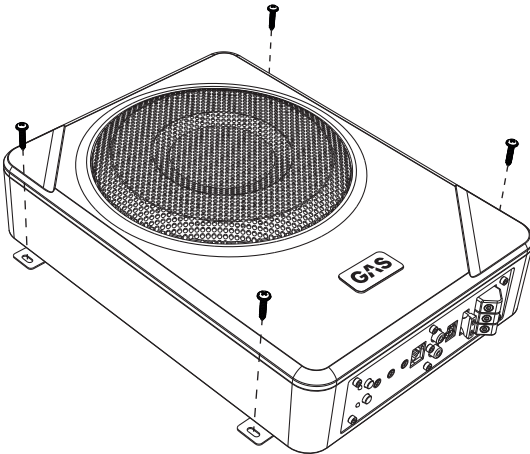

# HOW TO

*Find the best way to run the cables through your vehicle! This might take some time, and may vary between different models. Preferably the cables shouldn't be visible when you're finished and they shouldn't be placed in a way that they obstruct any of the vehicle's functions or hinder you from operating the vehicle safely. It's also important you don't run the power cable together with the signal cable, since this can cause interference. Make sure to use high quality signal cables to avoid noise problems.*

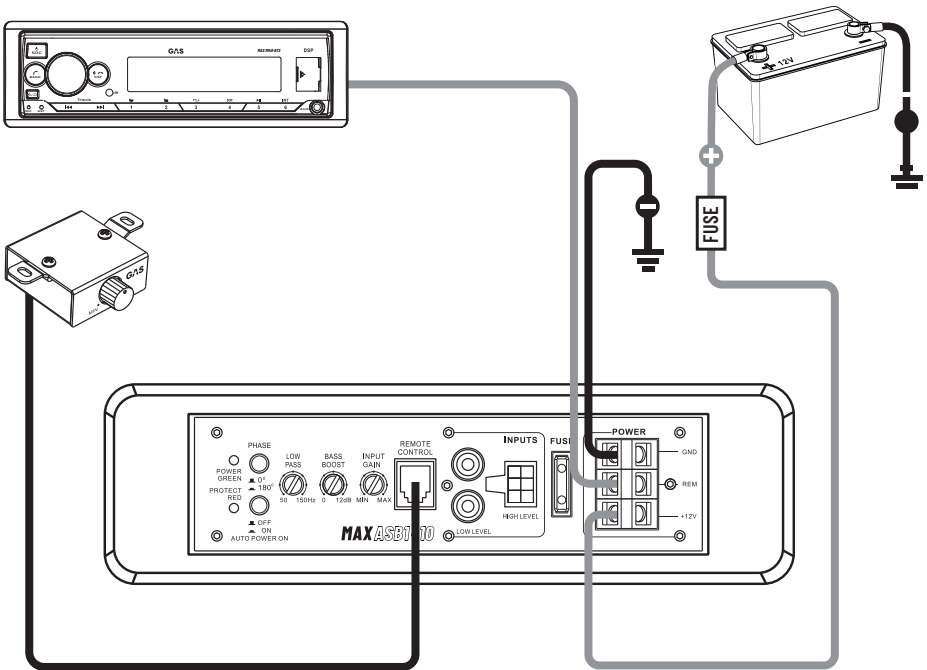

# HOW TO

## LOW LEVEL INPUT (RCA)

For audio connection between the head unit and the active slim subwoofer, you can either use Low Level Input (RCA) or High Level Input. Low Level Input (RCA) is preferred for the best audio performance.

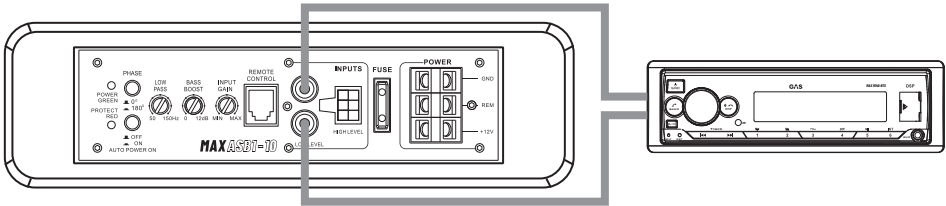

## HIGH LEVEL INPUT (HI)

If you don't have any RCA outputs on your head unit you can use the high level input function instead. Use the included HI input cable. This will connect the speaker output of the head unit directly to the active slim subwoofer's amplifier. When you use the high level input the subwoofer's amplifier will turn on automatically when the head unit starts. This means you don't need to connect the REM (remote cable) to the subwoofer's amplifier.

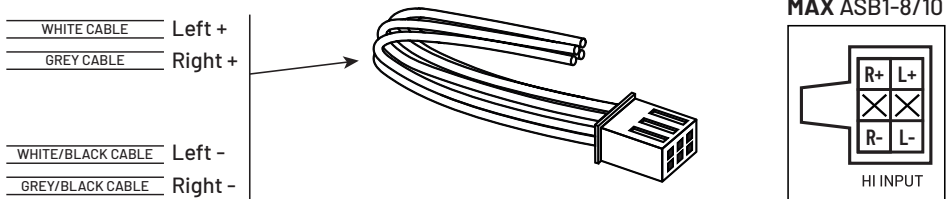

**WARNING!** Do not connect Low Level Input and High Level Input at the same time. This might cause damage to the ASB1 product and to your sound system.

# HOW TO

## TWEAKING & SETTINGS

The devil is in the details. Tweak the settings on your MAX active slim subwoofer using the following recommendations and cross the line that separates the average user from the hardcore high-power audio junkie!

### INPUT GAIN/VOLTS

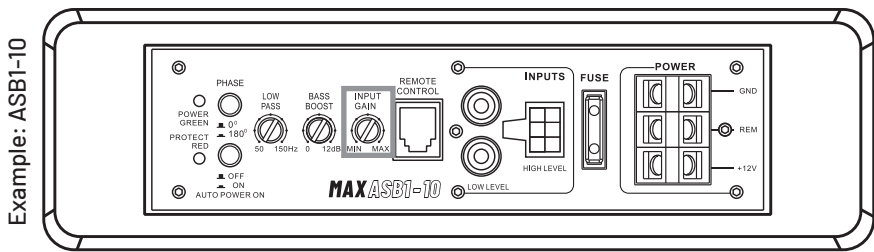

**Remember that the gain setting is not a volume control!** It's there to let you sync your head unit's output signal with the amplifier.

Every sound system is different, and there are several ways to set the amplifier gain. To get started you can use your own senses and audio skills by following the instructions below.

### Use your own senses and audio skills

If you are planning to set the gain by hand, do so in a quiet environment. The more experience you have in making this sort of settings, the easier it is to get a good result. If you haven't done this before, a tip is to ask a friend to help you out.

- Set the gain to minimum.
- Set the volume on your head unit to 75%.
- Start to play your favourite track that you are really familiar with and knows the sound of by heart, or use the test tones on a sine-wave test CD or digital test track.
- Slowly start to increase the level/gain.
- When you hear that the sound starts to change and you can note distortion, stop and turn the gain down slightly.



# HOW TO

## CROSSOVER (LPF)

Example: ASB1-10

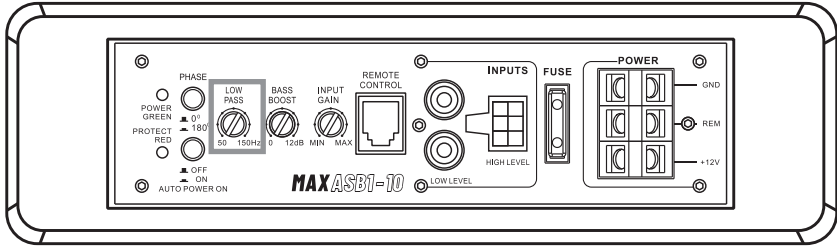

The Low Pass Filter crossover is used to regulate the maximum and minimum frequencies each speaker is allowed to reproduce. Check out the ASB1 active slim subwoofer's frequency response in the Specification section. Don't allow the Low Pass Filter to pass through lower- or higher frequencies than your subwoofer can handle.

The different frequency bands reproduce different types of sound:

HZ	20-40	40-80	80-160	160-320	320-640	640-1280	1280-2560	2560-5120	5120-10200	10200-20400
Band Type	Low bass	Mid bass	Upper bass	Lower midrange	Middle midrange	Upper midrange	Lower treble	Middle treble	Upper treble	Top octave

**Low Pass Filter (LPF):** 30Hz- 4000Hz variable, no frequencies above the chosen frequency cut point are allowed to pass through to the subwoofer.

# HOW TO

## BASS BOOST (EQ)

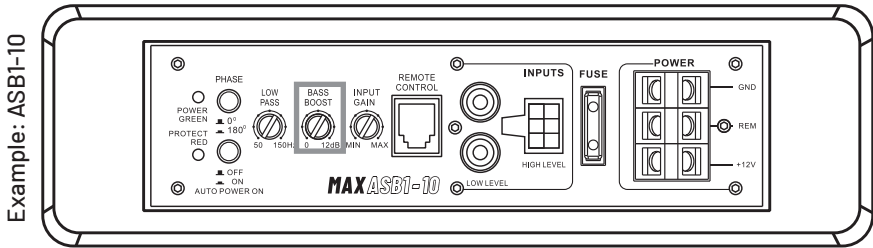

If everything is tuned correctly and the gain has been set, the BASS BOOST should remain in default (0dB). This function will apply level/gain at 45Hz centre frequency. Be advised that equipping the bass from 0-12 dB is a lot, an increase of +3dB doubles the output!

**WARNING!** The information below is for experienced users and bass addicts only, if you are new to the wonderful world of low frequencies, leave the BASS BOOST in default mode or consult with your local GAS AUDIO POWER dealer.

If you use the BASS BOOST, make sure to turn down your gain first (to 0) before you start adjusting it. Start a music track and very carefully turn the BOOST dial up until you start hearing distortion, then follow the HOW TO chapter about gain to optimize your system.



Incorrect usage of the BASS BOOST can permanently damage your subwoofer.

# TROUBLESHOOTING

## NO POWER/SOUND

Start by looking over the active subwoofer to make sure it isn't damaged. If your active subwoofer doesn't get any power, the most common issue is either in the wiring or in the amplifier. Use a multimeter to measure the amplifier's voltage on the +12V terminal and the remote signal terminal. Use a multimeter to make sure that you have a negative ground connection. Check the built-in fuse on the active subwoofer's amplifier. If there's no power coming through - control the fuse on the power cable. If this is intact - make a full check of the wiring to ensure cable integrity.

Check all the speakers connected to your sound system. Check all the speaker cables and all the signal cables. Check your head unit to make sure no settings are limiting the amplifier's functions or the active subwoofer. When all of the above has been tested/looked over, and all is as it should be but there's still no sound, consult your local GAS AUDIO POWER dealer.

## UNWANTED NOISE

Start by looking over the active subwoofer and other speakers in the sound system so there is no damage or connection issue with the wiring. Make sure that your signal cables or speaker cables aren't too close to the power cables. Check your amplifier's grounding point and make sure that the surface is clean. When all of the above has been tested/looked over, and the unwanted noise does not vanish, consult your local GAS AUDIO POWER dealer

## DISTORTION

Start by looking over the active subwoofer and other speakers in the sound system so there's no damage or connection issue with the wiring. Check the speaker cables to make sure that the polarity isn't reversed on one channel. Check the settings on the subwoofer's amplifier, make sure that the gain is set according to the amplifier's instructions. Lower the effects of the slim subwoofer amplifier's Bass BOOST settings, or turn it off.



# WARRANTY & DISPOSAL

This product is covered by warranty, depending on the conditions in the country where it's sold. If the equalizer is returned for service, please include the original dated receipt (or a copy) with the product. Make sure that the equalizer is packaged properly and secured, preferably in its original packaging.



The crossed-out wheellie bin symbol means that the product, literature and packaging included must be taken to separate collection at the end of their working life. Don't dispose of these products as unsorted municipal waste: take them for recycling. For info on your nearest recycling point, check with your local waste authority.



This product has been granted with the CE certification mark to show that the product follows the health, safety, and environmental protection standards for products sold within the European Economic Area (EEA).



GAS Audio Power products comply with the relevant provisions of the RoHS Directive for the European Union. In common with all Electrical and Electronic Equipment (EEE) the product shouldn't be disposed of as household waste. Alternative arrangements may apply in other jurisdictions.



GAS Audio Power is a global partner of the European Mobile Media Association, an organization that focus on promoting the custom made mobile media installations to consumers.

# THE GAS WORLD

You've entered the world of GAS. We aim to please, and we've made sure to have products made for you. No matter what stage of the LOUD-addiction you might find yourself in, there is a GAS product to fill your need.

## ***MAD***

Just starting out? The MAD series is made to play LOUD and to be the express lane to a no bullsh!t sound system that will make sure everyone can hear you coming!

## ***MAX***

The MAX series holds products made to deserve the center stage. Powerful, heavy duty and designed to be noticed. We made NO COMPROMISES because we know that you wouldn't accept it.

## ***CMP***

The CMP series has been developed for the crucial seconds when the dB-counter starts to tick. All CMP products have hand-picked, high quality, COMPETITION GRADE components and they are specially designed to withstand an awesome amount of power.





# THANKS FOR JOINING GAS AUDIO POWER!



**GAS**  
**AUDIO POWER**

GAS AUDIO POWER and SHAKY are registered trademarks by Winn Scandinavia AB and is protected by relevant laws and jurisdictions such as Copyright and Trademark laws.

Winn Scandinavia AB | Elementvägen 15, 70227 Örebro, Sweden | [www.winnscandinavia.com](http://www.winnscandinavia.com)

Winn Scandinavia AB reserves for possible typos, factual or numeric errors that may have been printed on any products, package designs, user manuals and/or other included accessories.





**GAS**  
AUDIO POWER