

MAXVIEW



MXL050 Roam

Installation & User Instructions

UK contact:

Helpline: +44 (0)1553 811000
Email: support@maxview.co.uk
Web: www.maxview.co.uk

Maxview reserve the right to change specifications without prior notice
9111431 Iss 3

Maxview Roam Powered by  **TELTONIKA**

We have partnered up with one of the largest suppliers of Wi-Fi products worldwide.

Introduction

Thank you for purchasing this product, should you have any difficulty using your Roam Mobile 3G/4G Wi-Fi System please contact our friendly Customer Helpline on +44 (0)1553 811000 or email support@maxview.co.uk.

Contents

- 2. Record your Purchase
- 3. Product Contents
- 3. Tools Required
- 3. Choosing a Service Provider
- 4. Accessories

Installation Instructions

- 6. Positioning your Roam
- 6. Important Antenna Installation Information
- 7. Fitting the Antenna
- 9. Router Installation

Router - Getting Connected and Basic Functions

- 11. Get to know your Router
- 12. Getting Online
- 14. Factory Reset

Router - Advanced Functions and Changing Router Settings

- 16. Connecting to the Web User Interface
- 18. Logging out of the Web User Interface
- 18. Setting Router Language

Router - Changing the Primary Internet Source from 3G/4G to Wi-Fi

- 20. Changing the Primary Source

Router - Other Functions

- 25. Managing and Removing Wi-Fi Connections
- 25. Changing Wi-Fi SSID (name) and Password
- 28. Entering SIM PIN
- 29. Controlling Data Usage
- 30. The Teltonika App
- 31. Router Firmware Update

Additional Information

- 32. General Safety Warnings
- 32. Terms and Conditions
- 33. Maintenance
- 33. 1 Year Guarantee
- 34. Troubleshooting & FAQ's
- 36. Specifications
- 36. Certification and Environment

Record your Purchase

Please fill in the details below once purchased. This information will be required in the unlikely event of a fault occurring with this system.

See page 11 to see where you can find this information.

SERIAL NUMBER

SSID

PASSWORD

Product Contents

- A. Omni-directional Roof Mount Antenna
- B. 0.8m cables with SMA connectors
- C. 3G/4G and Wi-Fi Router
- D. 12V Vehicle Power Supply
- E. 230V Mains Power Supply
- F. Router Mounting Bracket and Fixing Kit
- G. 1.5m Ethernet Cable
- H. Internal Wi-Fi Antenna
- I. SIM Card Pin Needle
- J. Roof Clamp
- K. Fixing Template
- L: No. 6 Screws x 3

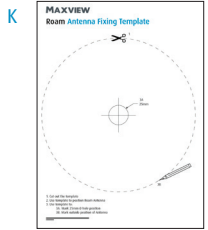

Tools required

- Power Drill
- 2.5mm Drill Bit
- 25mm Hole Saw
- Cross Head Screwdriver
- Hack Saw
- File/Emery Paper
- Surface Cleaner

Choosing a Service Provider



To use the Maxview Roam, you will need a suitable data SIM card (sold separately). The Maxview Roam is unlocked, so you can use any service provider.

The best package will depend on many factors such as data usage, budget, location of travel and usage habits, however pre-paid data plans are usually more cost effective.

For UK customers, our testing has highlighted THREE™ as a reliable and cost effective service provider. We offer 12GB and 24GB THREE™ pre-paid data SIM Cards (see page 4). For more information on choosing a service provider see www.maxview.co.uk or call helpline.

Mounting Accessories - Sold separately

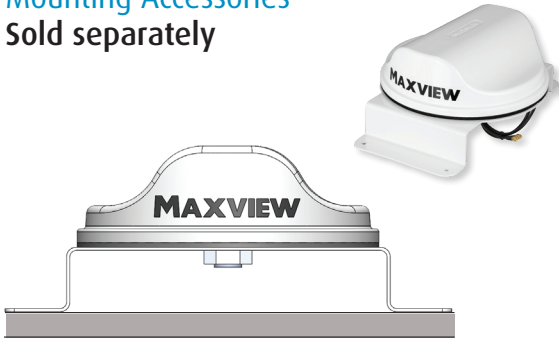

Roam Bracket Fitting Kit

The raiser bracket allows you the flexibility to mount your antenna anywhere on your roof and enter the cable at your preferred point using the supplied cable entry cover. Alternatively you may have an existing cable entry point you may like to utilise instead.

Designed and manufactured specifically for the Roam Antenna, the aluminium bracket is lightweight, strong and finished with a durable white powder coating.

Suitable for any flat roof the kit also includes 3m extension cables for flexible mounting position.

We always recommend the cable join is inside the vehicle. Cable securing clips and screws are also included. The bracket can also be mounted using a flexible adhesive. (Not included).

MXL050/KIT1

Accessories - Sold separately

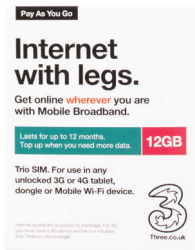

Data SIM packages

12GB SIM12GB
24GB SIM24GB



Roam Extension Cables

Extension cables can be purchased separately to allow a flexible mounting position to the router.

1 metre MXL050/EXT1 3 metres MXL050/EXT3
2 metres MXL050/EXT2 5 metres MXL050/EXT5

Installation Instructions



Positioning your Roam

- Distance between Router and Antenna

For best performance, we recommend mounting the router in close proximity to the roof mounted antenna. For best performance, only use the antennas standard 0.8m coaxial cables.

This means, once you have a suitable location for the router inside the vehicle, you must also ensure there is a suitable space on the roof to position the antenna in close proximity to the router. For example, if you would like to position your router in an overhead cupboard, we recommend mounting the antenna directly above the cupboard space.

- Roof Antenna Space

We recommend leaving 30cm gap from obstacles around the antenna to avoid interference issues.

- Router Wi-Fi Antenna Space

The internal router can be mounted in a horizontal or vertical orientation. However, bear in mind that the Wi-Fi antenna must be vertical for maximum performance. You must leave enough space for this.

- Power Supply

The router comes with 12V cigarette adaptor and 230V mains power supply. You should ensure your router power supply can reach your preferred power source.

Important Antenna Installation Information



1. The 3M seal provides a permanent installation. The adhesive is extremely strong and the antenna is not designed to be removed. Please ensure you are completely happy with your antenna's position and orientation before installation.

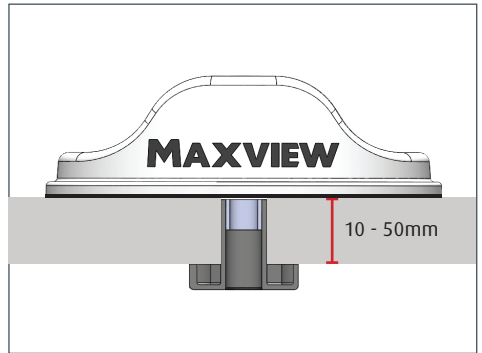

2. The Roam antenna is designed to be mounted directly to a horizontal, flat and smooth surface such as GRP (Glass Reinforced Plastic) with the coaxial cables passing directly through the roof underneath the centre of the antenna. The standard installation is designed for roof thicknesses from 10mm up to 50mm.

If this does not suit your installation, please see our mounting accessories (page 4) for a more suitable mounting option.

Fitting the Antenna

These instructions are for the standard through-the-roof installation as supplied.



1. Once you have a suitable position for the antenna, cut out the supplied template. Use to mark the 25mm centre hole position and mark the outside of the antenna.

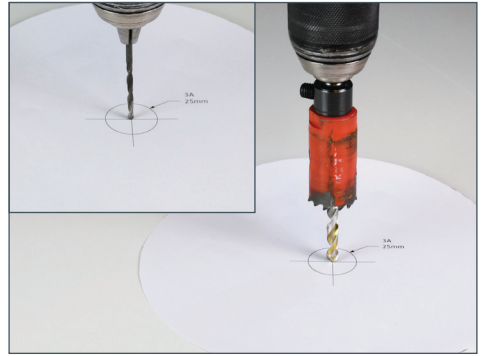

2. At the marked centre position, drill a 2.5mm pilot hole through the roof. Use a 25mm hole saw to drill out the centre hole through the roof.

Tidy up the hole to remove swarf and sharp edges.



3. Use the Antenna Clamp to gauge the depth of the roof. The best way to do this is to sit the Antenna clamp upside down through the hole. Then, from the inside, mark on the clamp where the clamp passes through the ceiling and into the vehicle.

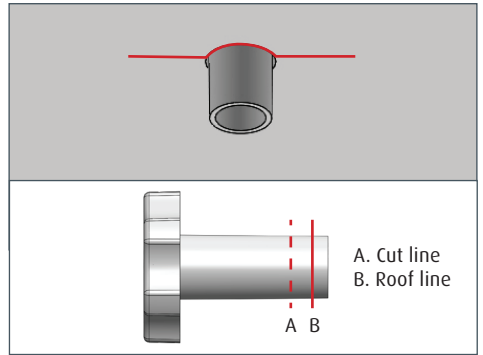

4. Remove the clamp and cut the clamp shaft to the correct length. The correct length for your installation will be the roof depth minus 3mm. This will ensure the clamp does not bottom out on the antenna when tightened.

E.g. If roof depth is 30mm. The clamp shaft should be cut 27mm along the shaft.



5. Clean the surface where the antenna will be installed, ensuring it is free from debris and grease.

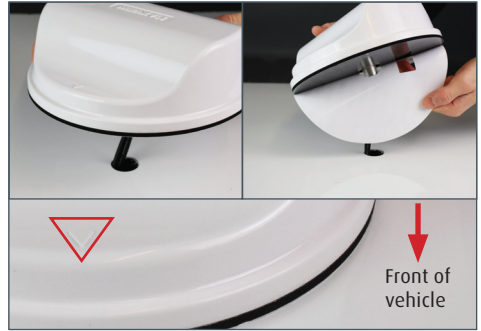

6. Pass the cables through the hole and remove the self-adhesive backing from the 3M seal. Pass the cables through the roof and position the antenna with the embossed arrow facing the front of the vehicle and the outside edge of the antenna aligning with the marks added earlier.



IMPORTANT - Ensure the position of the antenna is central to your markings, as once stuck down, the antenna is not designed to be removed.



7. Press firmly around the edges of the antenna to ensure a watertight seal has been achieved.

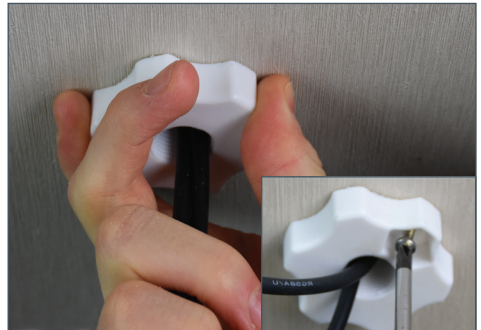

8. From the inside of the vehicle, attach the clamp and turn clockwise onto the thread protruding from the bottom of the antenna. Continue to turn until the clamp is compressing the seal underneath the antenna.

9. Once in position, use 1 x No.6 Screw to secure the clamp in position.

Router Installation

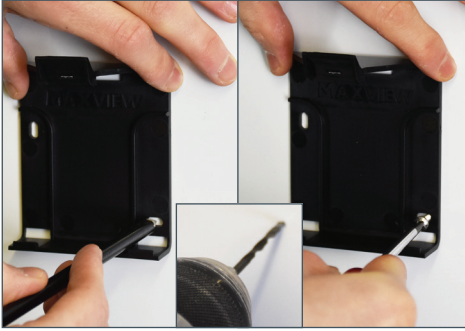

1. Position router bracket and mark hole positions. Depending on material, drill a pilot hole or use a bradawl. Mount the router mounting bracket to the surface using the 2 x No.6 Screws provided.



2. Use the Needle Pin to remove the SIM card holder. Place your SIM card of choice in the holder and slide back into the router. See page 4 for more information on SIM card preferences.



3. Attach the antenna coaxial cables to the bottom 2 connectors. These are marked 'mobile'. Note the order of the cables does not matter.



4. Attach the Wi-Fi antenna to the top connector. This is marked 'Wi-Fi'. This should be positioned so it is vertical.



5. Connect the 12V power lead or the 230V PSU and route the lead to your power source.



6. Place the router into the mounting bracket. The router can be removed from the bracket at any time to change the SIM card as required.

7. The installation is now complete. You may wish to tidy up cable routing to suit your installation.

Router

Getting Connected and Basic Functions



Get to know your Router

Left View

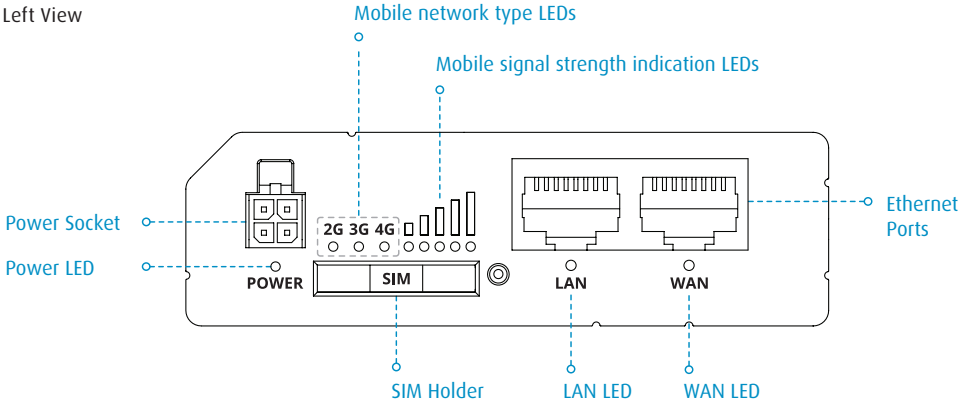

Right View

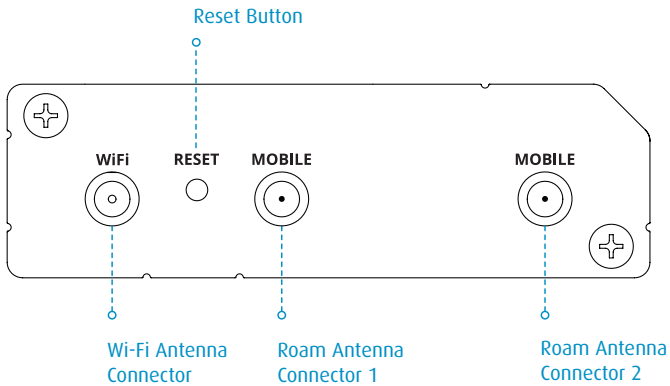

Credential Router Sticker (Located on the reverse of the router).

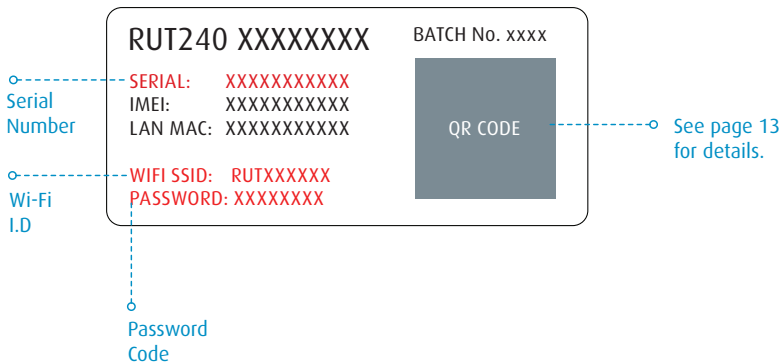

Getting Online

Now your Roam is installed and you have inserted the SIM card, it's time to get connected. To do this, you will need to be using a device which can connect to a Wi-Fi network such as a smart phone, Smart TV, tablet or laptop.

1. Turn on router and allow 2 to 3 minutes for the router to boot.

When ready, the router name will be visible in your devices Wi-Fi settings. There are 2 methods of connecting your device to the routers Wi-Fi network.

- Option A – Using device settings
- Options B – Using QR Code

Option A: Device Settings

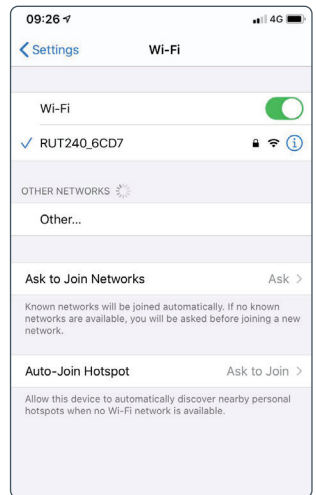
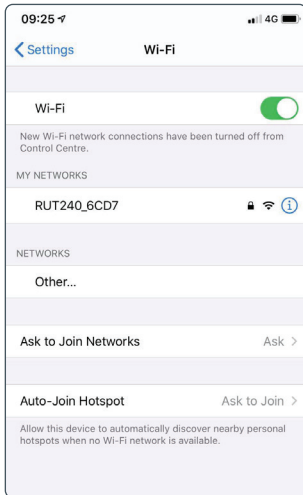

1. Navigate to your devices Wi-Fi settings and view available Wi-Fi networks.

2. The Roam router will be displayed as RUT240_XXXX. The last 4 characters will be unique to your Roam router.

If more than one Roam is being used within close proximity, the Wi-Fi network name is displayed on the back of the router.

See page 11 for code.

3. Once you select this network, you must enter the password. This is also printed on the back of the router.

 **Note: Password is case sensitive.**

See page 11 for code.

4. You are now connected and can begin using your Roam.

Option B: QR Code

1. If your device is able to read QR codes (Android 9 or newer and iOS 11 or newer), simply point your device camera at the QR code on the back of the router. When prompted, select 'join'. Your device will automatically connect to the Roam router.

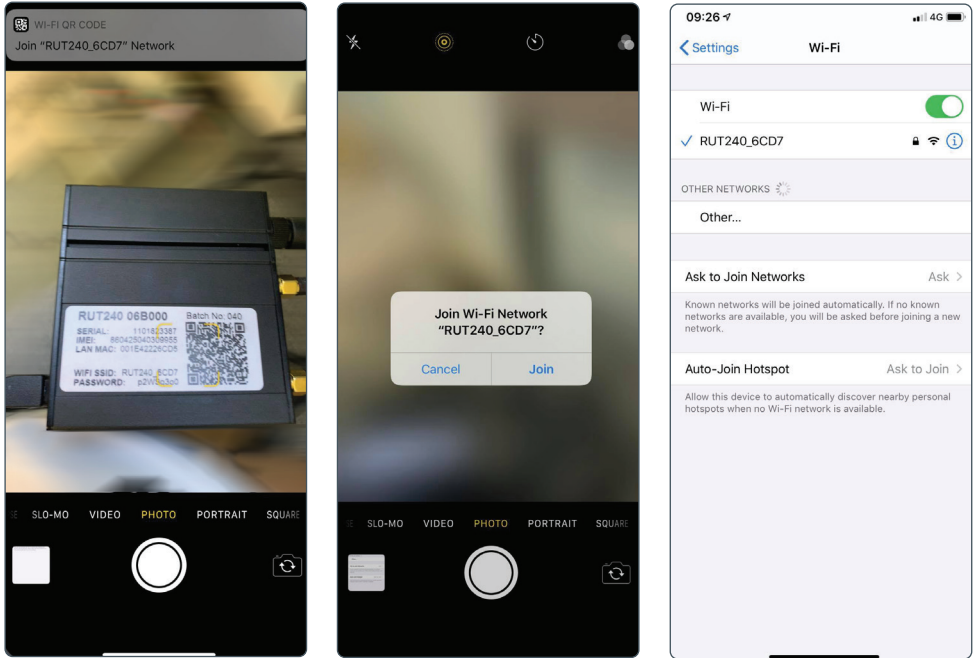

That's it! You are now connected to the secure Wi-Fi hotspot of your Roam Router.



The Wi-Fi network name and password will remain the same as those listed on the back of the router. The above processes can be repeated to connect up to 50 devices to the same network simultaneously.

Connecting to a device using an Ethernet Cable

If your device does not support Wi-Fi or you would like to maximise the reliability of your connection, you can access the Roam internet connection by connecting the Ethernet Cable between the LAN ports on the router and your device. Possible applications for this include some Smart TV's and desktop computers.

To do this, simply connect the Ethernet cable to the router and your device. If necessary, navigate to your devices LAN settings and follow the prompts.



When the ethernet is in use other devices can still connect to the router using Wi-Fi

Factory Reset

At any time, the Roam router can be reset to its factory settings using the reset button on the side of the router. This will restore all settings on the router, including:

- Router SSID (network name) and password to those listed on the back of the router.
- Web User Interface to the username and password listed on the front of the router.
- All custom settings will be deleted, including any Wi-Fi connections you may have added.

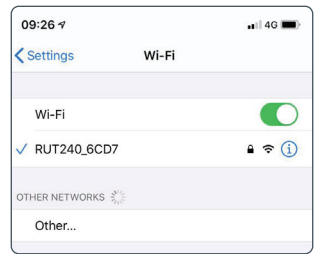
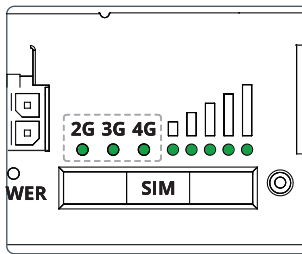
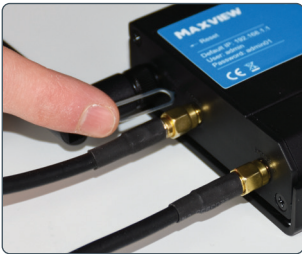

1. To complete the factory reset, press and hold down the reset button with the supplied pin needle.

2. Hold for 6 seconds, until all of the green LEDs on the side of the router are on.

Once released all 5 signal strength LED's will flash together.

This indicates the start of the reset process.

3. Allow 3 minutes for the router to reset. Once reset the Wi-Fi network will be visible and available to connect to.



Note: If you don't hold long enough, the router will restart but not reset.

Router

Advanced Functions and Changing Router Settings

For most users changing these settings is not necessary. We only recommend accessing and changing settings in the Web User Interface if necessary and we do not recommend changing settings which have not been outlined in this booklet.



Advanced Functions and Changing Router Settings

All of the settings and functionality of the Roam router are changed using the Web User Interface. This can be accessed using a browser when your device is connected to the Roam Wi-Fi network. The Roam router is very powerful and there are many settings in here which can be adjusted to suit your requirements.

For most users, changing these settings is not necessary. We only recommend accessing and changing settings in the Web User Interface if necessary and we do not recommend changing settings which have not been outlined in this booklet.

Connecting to the Web User Interface

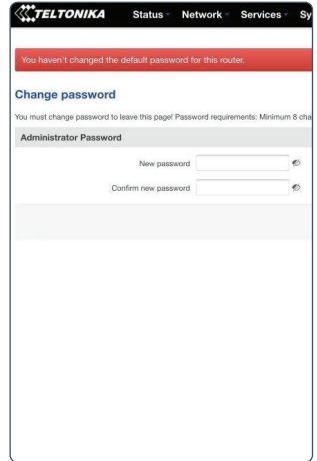
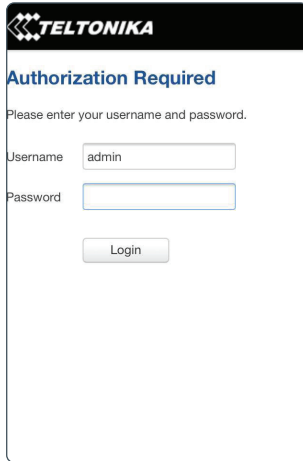
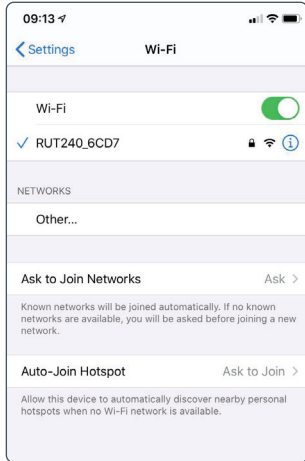



1. Whilst connected to the router, browse to **192.168.1.1** in your web browser. This can be done on any device with an internet browser and a connection to the Roam Router.

2. You will first be prompted to enter the Web User Interface user name and password. The default details are printed on the front of the router.

Username: **admin**
Password: **admin01**

3. On first use, you will be required to update the password. The new password must be a minimum of 8 characters and contain at least one upper case letter, one lower case letter and one number.

 These are different to the Router Hotspot SSID and Password.

 After completing this change, the original credentials listed on the front of the router will no longer work. If you forget your password, you will need to complete a factory reset to reset to the original credentials.

TELTONIKA Status Network Services System Logout

FW ver.: RUT2XX_R_00.01.04.2

Step 1 - General Step 2 - Mobile Step 3 - LAN Step 4 - WiFi Step 5 - RMS

Step - General

Please select your timezone.

Time Zone Settings

Current system time 2019-12-18 09:02:55 Sync with browser

Time zone UTC

Skip Wizard Save

4. When accessing the Web User Interface for the first time, you will be offered the chance to use the Set Up Wizard. This can be used to set up the router's most relevant parameters, such as changing the hotspot username and password.



Competent users can navigate through other settings, however we recommend skipping the Set Up Wizard as it is not strictly necessary to change any of these settings. For most users we recommend skipping the installation by selecting 'Skip Wizard'.

TELTONIKA Status Network Services System Logout

FW ver.: RUT2XX_R_00.01.04.2

Overview

| | | | |
|-------------------|---|-----------------------|---|
| System | 9.0% CPU load | Mobile | -71 dBm |
| Router uptime | 0d 0h 23m 2s (since 2019-12-18, 08:42:00) | Data connection | 0d 0h 20m 5s (since 2019-12-18, 08:44:57) |
| Local device time | 2019-12-18, 09:05:02 | State | Registered (home); 3 UK; 4G (LTE) |
| Memory usage | RAM: 88% used FLASH: 7% used | SIM card status | SIM (Ready) |
| Firmware version | RUT2XX_R_00.01.04.2 | Bytes received/sent * | 19.5 MB / 10.3 MB |
| Wireless | ON | WAN | Wired |
| SSID | RUT240_6CD7 (AP) | IP address | N/A |
| Mode | 1- AP; 11 CH (2.462 GHz) | WAN failover status | Failover link is enabled |

5. You will now have access to the router's dashboard. This page displays useful data such as mobile, system and wireless data. Unless necessary, we do not recommend changing any of the dashboard settings.

You can return to the Web User Interface dashboard at any time by selecting the Teltonika logo in the top left hand corner of the Web User Interface.

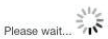

Please note - During some operations, the router can take several minutes to load. If you see this symbol please be patient as the router is working to save your settings.

Logging out of the Web User Interface

Once you have finished using the Web User Interface, you should log out. We recommend doing this every time you have finished using the Web User Interface.

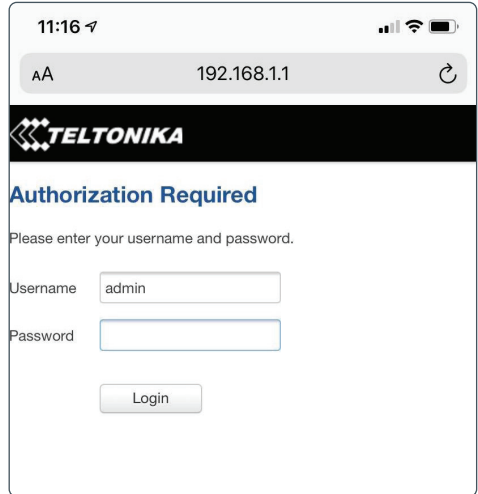
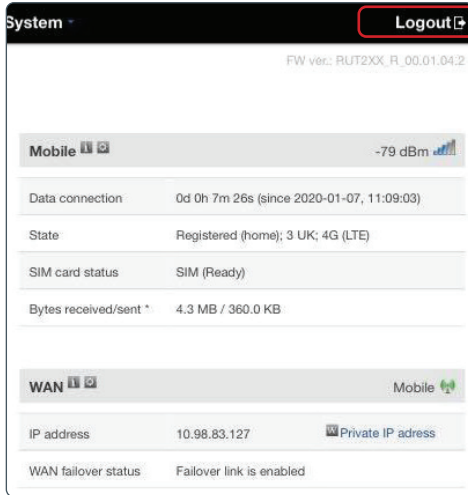

1. Select '**Log Out**' in the top right hand corner and confirm you wish to log out.

2. Once you have logged out you can now close the web browser tab and continue to use the Roam.

Setting Router Language

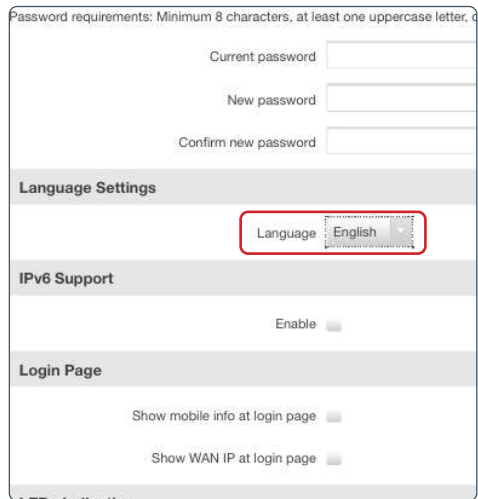
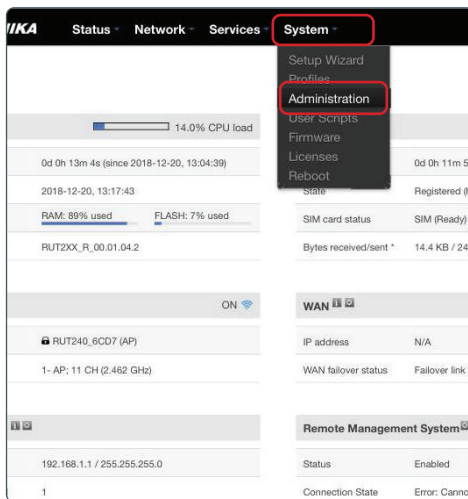

3. From the Web User Interface dashboard, at the top of the page select '**System**'. When the drop down menu appears, select '**Administration**'.

4. You will find '**Language Settings**' half way down the Administration Settings page.

5. Select your preferred language and select '**Save**'.

6. Select **Teltonika logo** to return to dashboard and begin using new language settings.

Router

Changing the Primary Internet Source from 3G/4G to Wi-Fi



Changing the Primary Internet Source from 3G/4G to Wi-Fi

In some instances during your travels, you will be in a location where there will be usable Wi-Fi connection which can be used as a source, instead of 3G/4G. This means you can access the internet using the same Roam hotspot, however the source of the connection will be from another Wi-Fi hotspot. To use an existing Wi-Fi hotspot, you will need to ensure it is either not password protected or you know the password which it is protected by. There is some set up required to use this feature, however this only needs completing once. The Wi-Fi source details will remain in the router and the router will automatically switch to using this Wi-Fi source instead of 3G/4G when it is available.

Because of the initial set up required, we recommend using this feature if you will be spending considerable time at this location or using significant data. If you will only be at the site for a short period, we suggest you continue to use the 3G/4G connection or connect directly to the Wi-Fi connection with your Wi-Fi enabled device.



The speed and reliability of the Wi-Fi connection you receive will only be as good as the source it is connected to. We therefore recommend you confirm the network is suitable for your requirements before carrying out the set up process. This can be done using a separate device with Wi-Fi connectivity, such as a mobile phone, laptop or tablet.

The screenshot shows the Teltonika router's web interface. At the top, there are navigation tabs: Status, Network, Services, and System. The 'Network' tab is selected and highlighted with a red box. A dropdown menu is open from the 'Network' tab, listing various network-related options: Mobile, WAN, LAN, Wireless, VLAN, Firewall, Routing, and Load Balancing. The 'WAN' option is highlighted with a red box. The background of the interface shows the 'Overview' page, which includes sections for System, Mobile, Wireless, and WAN. The System section shows router uptime, local device time, memory usage (RAM: 88% used, FLASH: 7% used), and firmware version (RUT2XX_R_00.01.04.2). The Mobile section shows data connection time, state (Registered (home); 3 UK; 4G (LTE)), and SIM card status (SIM (Ready)). The Wireless section shows SSID (RUT240_6CD7 (AP)) and mode (1- AP; 11 CH (2.462 GHz)). The WAN section shows IP address (N/A) and WAN failover status (Failover link is enabled).

1. From the Web User Interface Dashboard, select '**Network**' at the top of the page. When the drop down menu appears, select '**WAN**'.

Steps 2-5 are only required for first use. If you have completed steps 2-5 before, skip straight to step 6.

TELTONIKA Status Network Services System Logout

FW ver: RUT2XX_R_00.01.04.2

WAN

Your WAN configuration determines how the router will be connecting to the internet.

Operation Mode

| Main WAN | WAN Failover | Interface Name | Protocol | IP Address | Sort | |
|-------------------------------------|-------------------------------------|----------------|----------|--------------|------|------|
| <input type="checkbox"/> | <input type="checkbox"/> | Wired (WAN) | DHCP | - | | Edit |
| <input checked="" type="checkbox"/> | <input checked="" type="checkbox"/> | Mobile (WAN2) | None | 10.68.82.242 | ↑ ↓ | Edit |
| <input type="checkbox"/> | <input type="checkbox"/> | WiFi (WAN3) | DHCP | - | ↑ ↓ | Edit |

Save

2. The WAN page should now appear, which lets you determine how the router will be connecting to the internet. Your options here are Mobile (3G/4G), Wi-Fi or Wired.

TELTONIKA Status Network Services System Logout

FW ver: RUT2XX_R_00.01.04.2

WAN

Your WAN configuration determines how the router will be connecting to the internet.

Operation Mode

| Main WAN | WAN Failover | Interface Name | Protocol | IP Address | Sort | |
|-------------------------------------|-------------------------------------|----------------|----------|--------------|------|------|
| <input type="checkbox"/> | <input type="checkbox"/> | Wired (WAN) | DHCP | - | | Edit |
| <input checked="" type="checkbox"/> | <input checked="" type="checkbox"/> | Mobile (WAN2) | None | 10.68.82.242 | ↑ ↓ | Edit |
| <input checked="" type="checkbox"/> | <input type="checkbox"/> | WiFi (WAN3) | DHCP | - | ↑ ↓ | Edit |

Save

3. To ensure the Wi-Fi connection is used when available, the Wi-Fi option should be selected as the 'Main WAN' option. The mobile connection should then be selected as the 'WAN Failover' option.

4. Once the correct boxes have been selected, 'Save' these settings.



If you plan to use an Ethernet cable to connect your router directly to another access point, you should also select Wired as a 'WAN Failover'.

This can then be used when the router has no other way of connecting to the internet e.g. no SIM and no Wi-Fi source in range.

TELTONIKA Status Network Services System Logout

FW ver.: RUT2XX_R_00.01.04.2

WAN

Your WAN configuration determines how the router will be connecting to the internet.

Operation Mode

| Main WAN | Interface Name | Protocol | IP Address | Sort |
|---------------|----------------|----------|--------------|-----------|
| WiFi (WAN) | WiFi (WAN) | DHCP | - | Edit Scan |
| Mobile (WAN2) | Mobile (WAN2) | None | 10.68.82.242 | Edit |
| Wired (WAN3) | Wired (WAN3) | DHCP | - | Edit |

Save

5. At this point it is important that you wait, while the router updates these settings.

This can take 2 to 3 minutes. Once the 'please wait' message at the top of the screen disappears, the settings have been applied.



It is only necessary to complete steps 2-5 once. Next time you want to add a Wi-Fi network, skip to step 6.

6. You will now see the order of connection methods has changed to suit your preference and a 'Scan' box has appeared next to the Wi-Fi option. Select 'Scan'.

TELTONIKA Status Network Services System Logout

FW ver.: RUT2XX_R_00.01.04.2

Site Survey

Warning! During scan wireless will be temporarily shutdown. If you are connecting to the router via its wireless Access Point or via its wireless WAN you will lose the connection and wont be able to inspect the result of the scan.

Start scan

7. Depending on your WAN settings, you may see the above warning message. If you see this message, select 'Start scan' to begin a search of the Wi-Fi networks within range of the router. If you don't see this, skip to 8.



8. Find your desired network, complete with Signal Strength and Encryption Type. Select your preferred Wi-Fi connection. If the Wi-Fi source is password protected you will be prompted to input the password (which will be case sensitive).



9. Because the wireless connection is now being reset, once complete the router will go to the wireless configuration settings. You will see the new network under 'Wireless Station Mode'

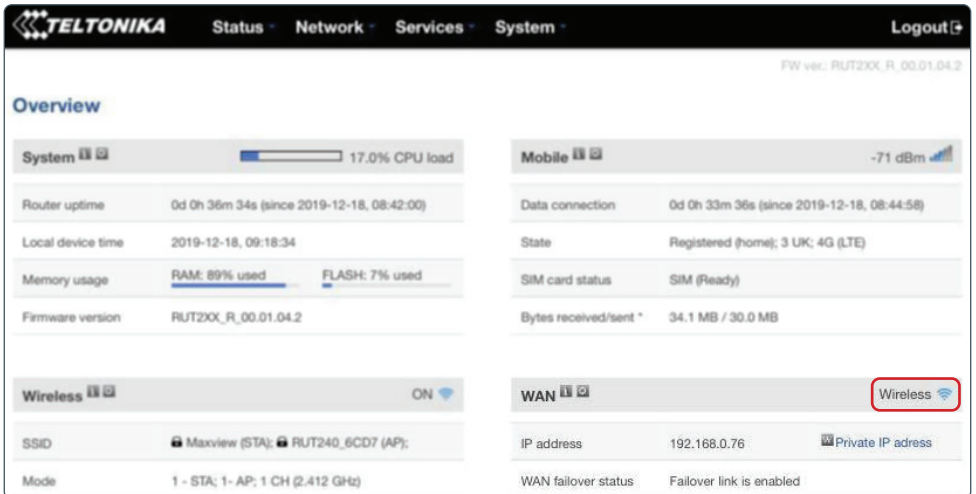

10. Select the Teltonika logo to return to the dashboard. You can ensure the router is connected using the Wi-Fi by checking the connection method listed in the WAN section of the dashboard.



Where no Wi-Fi connections are available, the router will return to the mobile (3G/4G) SIM card connection. There is no need to use the Web User Interface to switch back to a mobile SIM card connection.

Router

Other Functions



Managing and Removing Wi-Fi Connections

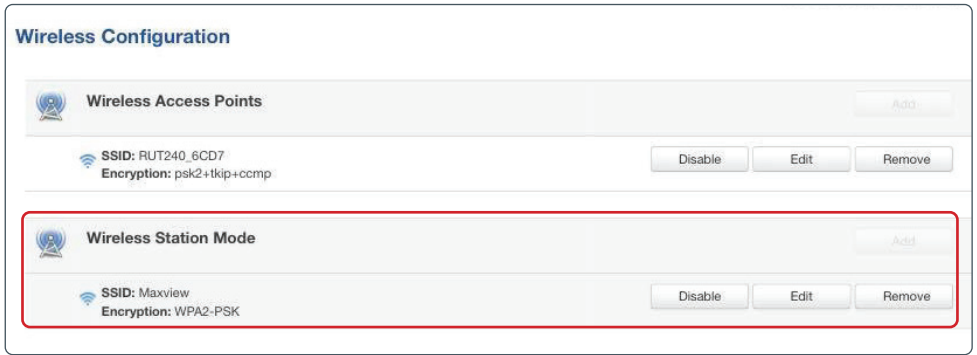

1. Navigate to '**Network**' and then '**Wireless**'. From here, you can then view and manage all Wi-Fi connections listed under the Wireless Station Mode heading. This includes updating Wi-Fi passwords and removing connections which are no longer required.



The Router will store the details of the most recently used Wi-Fi connections. See page 20 to input with a new connection.

Changing Wi-Fi SSID (name) and password

After completing this change, the original credentials listed on the back of the router will no longer work. If you forget your password, you will need to complete a factory reset to reset to the original credentials.



Completing this change will remove all devices which are currently connected to the router hotspot. These will need to be reconnected using the new username and password.

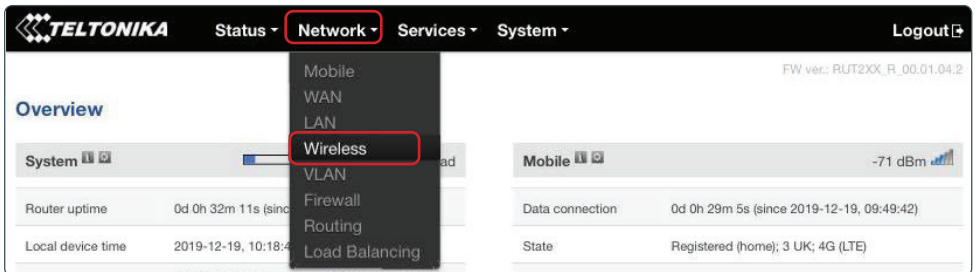

1. From the Web User Interface dashboard, select '**Network**' and then '**Wireless**' from the top menu.

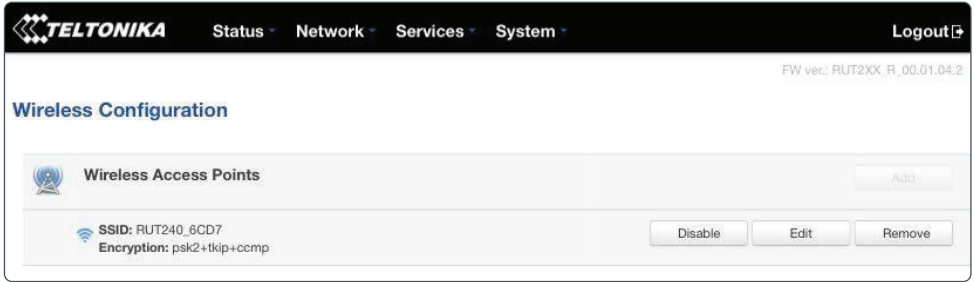

2. You will then see a list of the Wireless Access Points (hotspots) the router is creating. As standard, this will be just one. Select **'edit'** on the RUT240_XXXX access point.

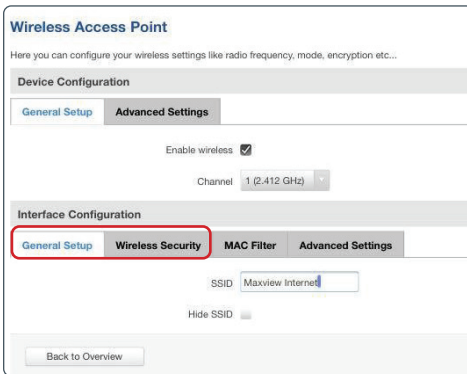

3. You will now be transferred to the **'General Setup'** tab. In the SSID box, input a new name (SSID) for your router. Once complete, select the **'Wireless Security'** tab.

Note - You not need to save before changing tabs.

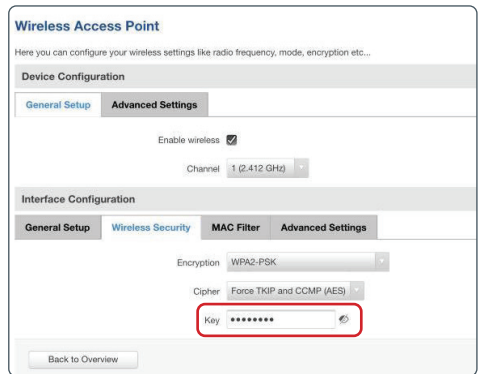

4. Input a new password in the **'key'** box.

 It is important this is a strong password to ensure your hotspot remains secure. We recommend using a combination of uppercase characters, lowercase characters, numbers and symbols. You should also avoid common phrases such as 'password' and '12345'.

Keep your password safe as it will be required to connect devices to the new Wi-Fi network.

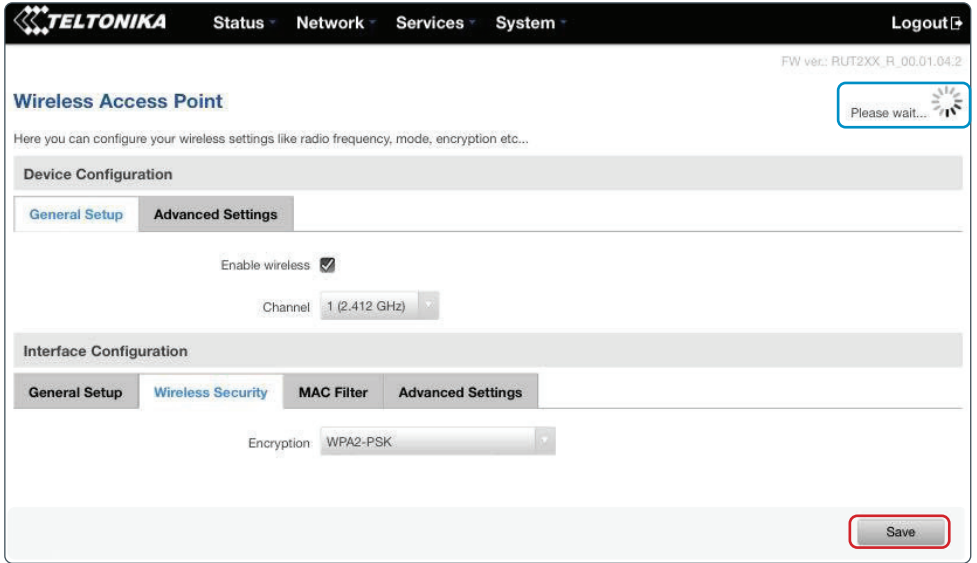

5. Once completed, select 'save'. The page will show a 'please wait' message whilst the settings are saved.

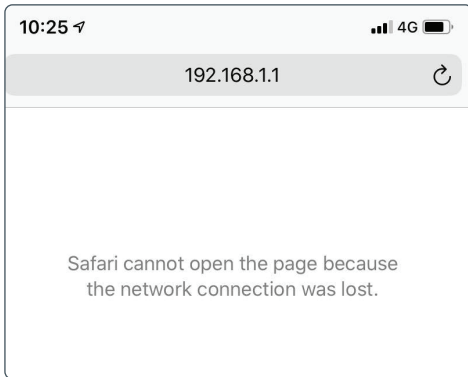
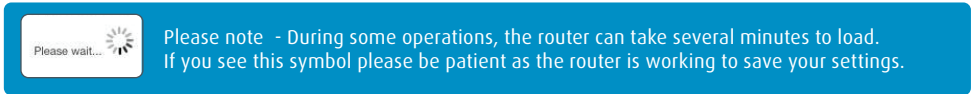

6. When the changes are complete, you will see a web browser error page and your device will no longer be connected to the router. Because the Wi-Fi network has changed, the router will automatically remove all devices, including the one you are currently with.

Your new hotspot name and password is now set up.

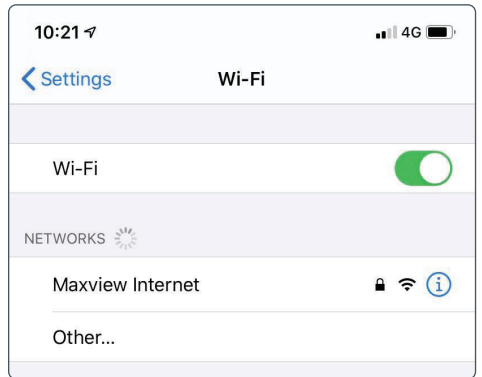

7. You can now navigate to your device's Wi-Fi settings and view available Wi-Fi networks. The Roam router hotspot will be displayed as your chosen name. Select this network and enter the new password.

This step should be repeated for any device you wish to connect.

Entering SIM PIN

For security, some SIM cards have a 4-8 digit PIN activated. If your SIM is PIN protected, you will need to input the PIN number into the Web User Interface before it can be used.

Please note, if you enter the incorrect PIN 3 times, your SIM card may be blocked. If this happens, you will need to contact your SIM card network provider.

If your SIM requires a PIN, the Web User Interface will display SIM (locked). If it does not require a PIN it will display SIM (ready).

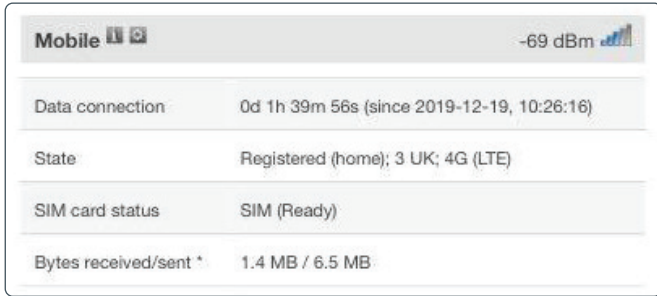

To enter the PIN, follow the below steps

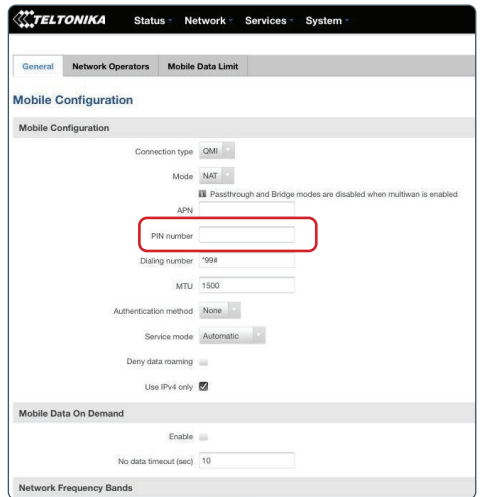
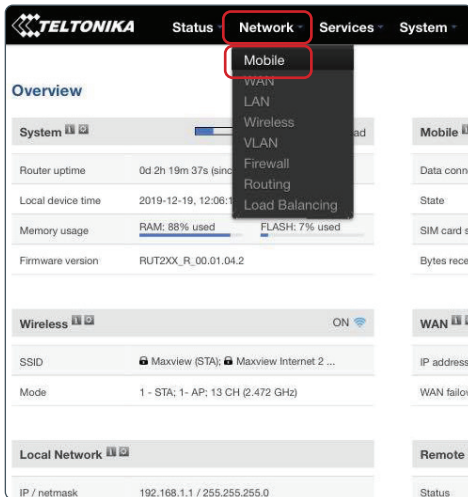

1. From the Web User Interface, select 'Network' and then 'Mobile' from the top menu.

2. In the 'General' tab, insert the PIN in 'PIN' box. Once entered, select save.

Controlling Data Usage

This function can be used to sync your SIM card's data allowance with the router. This configuration will not reset when the router is turned off so can be used to monitor usage and to understand when you are nearing your maximum allowance.

Warning: This should be used as a guide only. For exact usage and allowance usage, please contact your service provider.

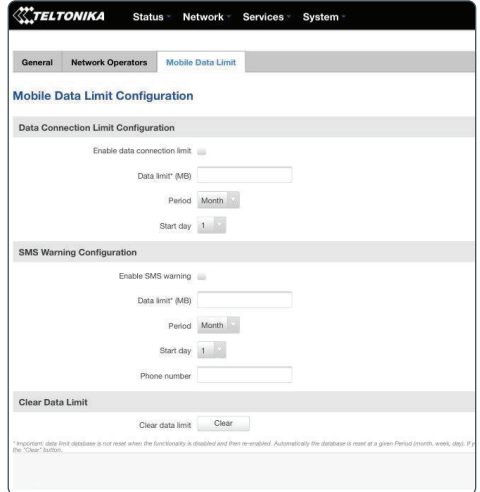
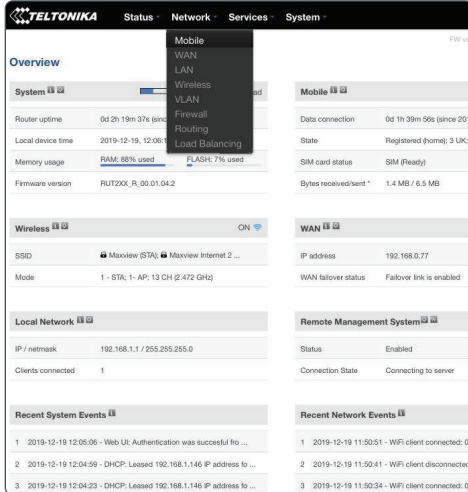

1. From the Web User Interface, select **'Network'** and then **'Mobile'** from the top menu.
2. Select the **'Mobile Data Limit'** tab.

3. To restrict data usage, a data connection limit can be enabled and entered (in MB not GB). This restriction will last for a determined time frame (day, week, month) and the limit can be set to start on the day of your choice.

4. SMS warning texts can also be set up in the same way, however this will send a warning text when you are nearing your allowance limit.

Typical Set Up Example - Purchased 12GB data SIM which lasts for 12 months.

- Input 11000 in SMS warning and set period to 12 months from current date and set period to yearly.
- Input 11900 in data limit and set period to 12 months from current date and set period to yearly.

This will notify to the mobile number of your choice when 11GB has been used and then limit data usage when 11.9GB have been used.

The Teltonika App

Teltonika also offer a handy app to provide basic functionality of the router such as monitoring usage statistics, setting Wi-Fi connection name and password and inputting SIM pins.

The Teltonika App is available on IOS and Android devices from the App Store and Google Play stores. Simply search '**Teltonika**' in the App search console and download the '**Teltonika Router**' app.

Note: This should not be confused with the '**Teltonika RMS**' app.

Once downloaded, as long as you are already connected to the Roam router, the app will recognise this and allow you to log in using the same log in details as those used for the Web UI.

All changes can be made using the settings wheel at the bottom of the app.

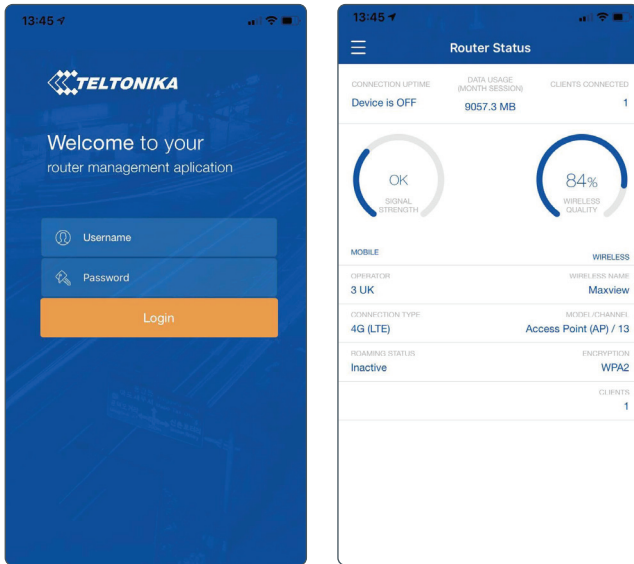

Other Functions

The Roam router offers a vast number of functions in addition to those listed above. These include features such as SMS remote control, accessing SMS messages and custom configuration. These features are advanced and should only be used by a competent user.

To bring you the Roam router, we have partnered with Teltonika. Teltonika have a vast amount of information available for all function of the router and Web UI on their Wiki Support Site. This can be accessed at: <https://wiki.teltonika.lt/view/RUT240>

For more information on the function available and instructions on how to use this, please refer to the Teltonika Wiki Support Site.

Router Firmware Update

From time to time, new firmware will be available to download onto the Router. It is not essential that the latest firmware is on the router, however we recommend keeping firmware up to date to ensure you have access to new feature releases and the latest security updates.

A list of the latest firmware changes and the associated features can be found at https://wiki.teltonika.lt/view/RUT2xx_Firmware

As long as the router has a reliable internet connection, the firmware update can be done from the Teltonika Web User Interface. The time it takes will depend on your connection speed, so we recommend using a fast connection to minimise the time required.

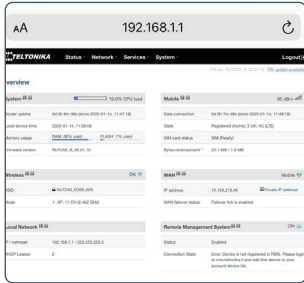

1. If a firmware update is available, you will see the words 'FW update available' in the top right hand corner of the dashboard.

2. Select the 'FW update available' text to proceed to the Firmware page.

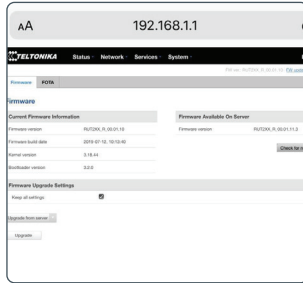

3. Select 'upgrade' to begin the update procedure. It is not necessary to change any of the other settings here.

Ensure 'keep all settings' box is ticked so router configuration and credentials do not change.

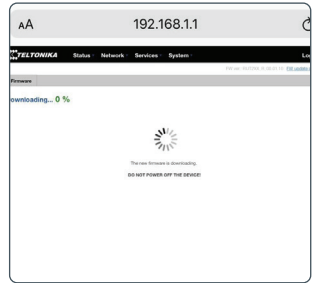

4. The firmware will now begin to download. Remain on this page until the download is completed.

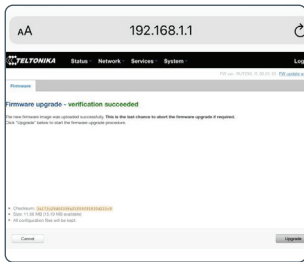

5. Once completed, the page will change to show that the download and verification has been successful.

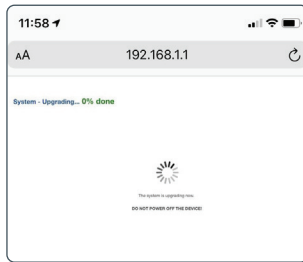

6. Select 'Upgrade' to begin the transfer of the new firmware onto the router.

7. Once completed, your browser should refresh and you will be logged out of the router.

If the page does not refresh automatically, you may need to refresh the browser.

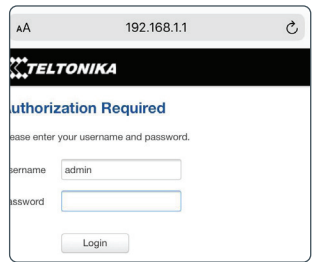

8. The upgrade is now complete. Log back in to the Web User Interface to check the firmware upgrade has been successful.

Note, as long as the 'keep all settings box' was ticked at step 3 the firmware update will not override the existing credentials.

Additional Information

General Safety Warnings

Read these instructions carefully and become familiar with your Maxview product. Understand the application, limitations and any hazards involved with the installation and operation.

Failure to follow all instructions may result in damage to your vehicle and/or serious injury. Maxview declines all responsibility in the event of incident or accident if they are due to a non observation of the installation instructions or the way the product is used.

No modifications to the product are permissible.

Installation

- Always consider the additional height the product you install adds to the vehicle
- Always follow manufacturer's operating instructions before using tools and equipment.
- Take care when working at heights. Keep work area clean and tidy to avoid trip hazards
- Use creeper boards where necessary to ensure roof construction can support your weight
- All electrical work should be carried out by a competent person

Operation

- The maximum speed of vehicle with product mounted on roof is 81mph (130km/h)

Servicing & Support

- Any inspection or repair must be carried out by Maxview or an appointed representative of the manufacturer
- No regular maintenance required on the product
- Do not dismantle product
- Do not use solvent or abrasive cleaning agents on the product
- Only use a suitable mild detergent to clean the product
- Do not pressure wash the product
- We recommend you check the mechanical integrity of a roof mounted product at least once a year
- If in the event that you do experience a problem with the product, call Maxview Customer Service +44 (0)1553 811000

Terms and conditions

In no event shall Maxview be liable for any indirect, incidental or consequential damages from the sale or use of the product. This disclaimer applies both during and after terms of the guarantee. This does not affect your statutory rights.

The Roam antenna is designed for permanent installation and is not designed to be removed or serviced. Whether the Roam is in warranty or not and whether the cause for removal is our fault or not, we are not responsible for the safe removal of the Roam antenna. Will not be held responsible or liable for any damage done to the Roam or other property whilst removing the antenna, regardless of the reason for removal.

By selling a Three™ SIM card we are acting completely independent of Three™ and any information you supply or any contract you enter in to is your own choice. We will not be held liable for any costs incurred as a result of using Three™ services. Three™ is a trading name of Hutchinson 3G UK Limited.

Data usage can be expensive. Although the Roam does offer data warning and restriction warnings, this should be used as a guide only, it is not always completely accurate. For accurate data usage information, you should contact your service provider. We will not be liable for any costs incurred as a result of data usage using the Roam.

Maintenance

The Roam has been designed to be maintenance and trouble free. For optimum signal strength, keep the cover clean from dirt, bugs, and other debris. Periodic washing of the top cover with mild soap and water is recommended.

1. Do not remove the cover of the antenna as it will void the limited guarantee.
2. Never power wash the antenna. Keep the enclosure clean from dirt, bugs, and other debris by hand washing with mild soap and water.

DO NOT USE SOLVENTS TO CLEAN THE ROAM. DO NOT DROP OR EXPOSE TO JARRING MOVEMENTS.

1 year guarantee

Every Maxview Roam Mobile 3G/4G Wi-Fi System is thoroughly inspected and tested before leaving the factory, and is covered by the following 1 year parts limited guarantee from the date of original purchase:

1 year parts guarantee: The customer is not responsible for the cost of replacement parts if the original part is determined to be defective under the terms of the guarantee. The customer is responsible for the cost of replacement parts after 1 year.

Should any problems develop during the guarantee period, contact Maxview. You must contact Maxview before the guarantee period expires. The customer must supply proof of purchase (such as a dated sales receipt) when requesting warranty service. If customer cannot supply proof, warranty period shall start 30 days after date of manufacture.

Only Maxview will perform guarantee evaluations and repairs.

If it is determined that the unit needs to be returned to Maxview, the customer must return COMPLETE product, to: Customer Services, Maxview Ltd, Garage Lane, Setchey, King's Lynn, Norfolk, PE33 0AT, England.

When returning product, Maxview will supply a Product Return Number (PRN). This number must be clearly written on the box. Failure to clearly write PRN number on box may result in delays in processing claim.

Along with product, customer should include in the box: name, address, daytime phone number, proof of purchase and description of the problem.

If inspection shows the trouble is caused by defective workmanship or material, Maxview will repair (or replace if necessary) without charge.

This guarantee does not cover installation and external wiring, or re-manufactured units. This guarantee does not cover damage caused by the use of a mounting bracket other than a Maxview mounting bracket designed for the product. This guarantee is not transferable from the original owner.

Due to expanding and changing telecommunications market, Maxview cannot be held responsible for changes made to communication services. Software updates to address such issues are not covered under guarantee.

This guarantee also does not apply where:

- The product has been abused, misused, improperly installed or improperly maintained.
- The product has been installed without the use of a Maxview mounting bracket designed for the product.
- Repairs have been made or attempted by others that are not certified by Maxview to do such repairs.
- Repairs are required because of normal wear and tear.
- Alterations have been made to the product.
- The antenna unit has been opened without authorisation.
- Damage has been caused by power washing.
- Circumstances beyond the control of Maxview cause the product to no longer operate correctly.
- Customer is not the original owner.

Troubleshooting and FAQ's

1. How can I test the speed of my connection?

There are various apps available that can be used to measure your upload and download speed. We recommend the Ookla speed test app, available from the App Store and Google Play Store. Before running the test, make sure your device is receiving internet through the roam router.

2. What Download speed do I need to watch TV through my Roam?

As a general rule of thumb, you will need 3Mbps to stream standard definition video and 5Mbps to stream high definition video.

3. My phone is connected to the Roam but I don't have any phone signal?

The Roam creates a WIFI hotspot which can be used to provide a Wi-Fi connection to your device. This means it can be used for all features on your device that use an internet connection. This includes Facetime, WhatsApp and Wi-Fi calls, but will not include traditional voice calls and SMS text messages.

4. I am connected to the Roam with a good Wi-Fi signal but nothing is loading?

If you are near to the Roam router, it is likely that you will have a strong Wi-Fi connection to the router. However, this doesn't mean that the Roam is receiving a strong signal from the 3G/4G network. We suggest trying a different location and ensuring you still have data on your SIM card.

If you are using the router to connect to an existing Wi-Fi hotspot, check the Wi-Fi source is reliable and has a good download speed before connecting the Roam to it.

5. Why has my phone got faster internet speed than my Roam?

The Roam has been optimised for remote and rural locations where our customers tend to travel. Using the router's 3G/4G capabilities in urban locations where the 3G/4G signal is strong, you should still be able to receive a fast internet speed (enough to stream HD TV). However, the Roam performs best when 3G/4G signal is limited, allowing you to use the internet when other devices can't.

6. I have forgotten my Wi-Fi password, what should I do?

You will need to carry out a factory reset. See page 14.

7. Where can I find more information about the advanced functionality of my router?

If this manual does not cover the function you wish to use, detailed step-by-step information on every function of the router is available at <https://wiki.teltonika.lt/view/RUT240>

8. Is there an easier way to change the settings for my router?

Most router functionality can be controlled using the Teltonika App. See page 30.

9. Does the Roam work on 5G?

The Roam is designed to receive 3G, 4G and Wi-Fi. Technically speaking, 5G uses a much shorter wavelength which means the signals do not travel as far. 5G is well suited to largely populated areas where transmitters can be placed at frequent intervals and signals can reflect off of buildings. This means 5G connectivity is unlikely to be available in rural and remote locations for some time. Because of the limited coverage, expensive data packages and the limited number of useful applications, Roam focuses on maximising 3G/4G signal at a cost effective price.

For the vast majority of our customers, 5G offers no benefits over 3G and 4G.

10. Does the Roam work when my vehicle is moving?

Yes, when the roam is using 3G/4G as the connection source (rather than Wi-Fi), the Roam will work when you are in motion.

11. Why do I lose connection to my Roam when I move in or out of range of the Wi-Fi source my Roam is using?

The Roam will automatically detect and connect to the Wi-Fi source you have set up in the Web User Interface. When the Roam detects that this network has become available (or unavailable), the router will switch from receiving Wi-Fi to 3G/4G (or vice versa). During this sequence, there will be a brief period where there is no signal available to the router. Because of this, some devices will disconnect from the Roam hotspot. If this is the case, simply reconnect to the Roam hotspot and you should be back up and running.

See page 23 to check how the Roam router is using Wi-Fi or 3G/4G to receive an internet connection.

12. I am revisiting a location where I have previously been connected to the Wi-Fi using the Roam. Why doesn't my Roam automatically reconnect?

When using an existing Wi-Fi hotspot as the connection source, the Roam will only store the last Wi-Fi hotspot used. If you are revisiting a location which was not the most recent location used, you will need to visit the Web User Interface to input the new Wi-Fi source details. For more information on how to do this, see page 25.

If the location you are revisiting is the last Wi-Fi source the Roam router was set up with, whilst located within good range of the Wi-Fi source, try rebooting the router. It should now automatically connect.

If this does not work, it is possible that the password for the Wi-Fi source has changed. If so, you will need to log into the Web User Interface and update the password. See page 25 for instructions on how to do this.

13. What are the lights on the side of the Roam router telling me?

Basic use and diagnosis using the LED's has been outlined below.

| Connection status LEDs | |
|--|---|
| The connection status LEDs are located on the left side of the front panel, between the power connector and the signal strength indication LEDs: | |
| The LED displays the router's current connection state and network type among a few other things: | |
| ACTION | DESCRIPTION |
| 2G, 3G and 4G LEDs blinking every 1 second | No SIM or bad PIN |
| Blinking from 2G LED to 4G LED repeatedly | SIM holder is not inserted or access to network is denied |
| 2G/3G/4G LED blinking every 1 sec | Connected to 2G/3G/4G, no data session established |
| 2G/3G/4G LED turned on | Connected to 2G/3G/4G with data session |
| 2G/3G/4G LED blinking rapidly | Connected to 2G/3G/4G with data session and data is being transferred |
| Signal strength LEDs | |
| The signal strength LEDs are located in the center of the front panel, to the right of the connection status LEDs: | |
| Each lit up LED represents a different value of the router's current signal strength in RSSI: | |
| NO. OF LIT UP LEDs | SIGNAL STRENGTH VALUE |
| 0 | ≤ -111 dBm |
| 1 | -110 dBm to -97 dBm |
| 2 | -96 dBm to -82 dBm |
| 3 | -81 dBm to -67 dBm |
| 4 | -66 dBm to -52 dBm |
| 5 | ≥ -51 dBm |

Visit wiki.teltonika.lt/view/RUT240_LEDs for a full list of the LED configurations and what these mean.

Specifications

Antenna

| | |
|-----------------|--|
| Type: | Omni-directional MIMO (multiple in multiple out) |
| Frequency: | 698MHz to 2700MHz (3G/4G) |
| Connector Type: | SMA |
| Peak Gain: | 698-960MHz: 2.5dBi / 1710-2700MHz: 5.0dBi |
| Impedance: | 50 Ohm |
| Power: | Passive |
| Cable Lengths: | 0.8m (cable extensions available separately) |
| Housing: | Aluminium Base. UV Stable ASA Cover |
| Dimensions: | ø: 196mm x H: 65mm |
| Weight: | 500g |

Router

| | |
|--------------------------|--|
| Router Type: | 3G/4G and Wi-Fi |
| Compatible Speeds: | Up to 150Mbps |
| 3G/4G Antenna Connector: | 2 x SMA |
| Ethernet Ports: | 2 x RJ45 (WAN and LAN) |
| Connection Devices: | Up to 50 |
| External Antennas: | 2 x 3G/4G (for external roof mount antenna) 1 x Wi-Fi (for internal whip antenna) |
| Power Supply: | 12V, 1A (includes 12V cigarette adaptor and 230V mains Power Supply) |
| Power Consumption: | 0.4A |
| Family Browsing: | Yes, blacklists and whitelists |
| Remote Diagnostics: | Yes |
| SIM: | Unlocked (No SIM provided) |
| Housing: | Aluminium |
| Dimensions: | H: 83 x W: 74 x D: 25mm |
| Weight: | 125g |

Certification and Environment



The Roam 3G/4G/Wi-Fi system has been designed, constructed and marketed in compliance with the safety and product requirements of the relevant EEC Directives.



Products marked with the crossed out wheely bin must not be disposed of with normal household waste but made available for separate household collection. Separate collection of used products and their packaging allows materials to be recycled and used again. Re use of recycled materials helps prevent environmental pollution and reduces the demand for raw materials.



The Directive on the restriction of the use of certain hazardous substances in electrical and electronic equipment 2002/95/EC.